

Σ SERIES SGM/SGD BULLETIN

FOR SPEED (TORQUE) CONTROL

SERVOMOTOR TYPE SGM
SERVOPACK TYPE SGD

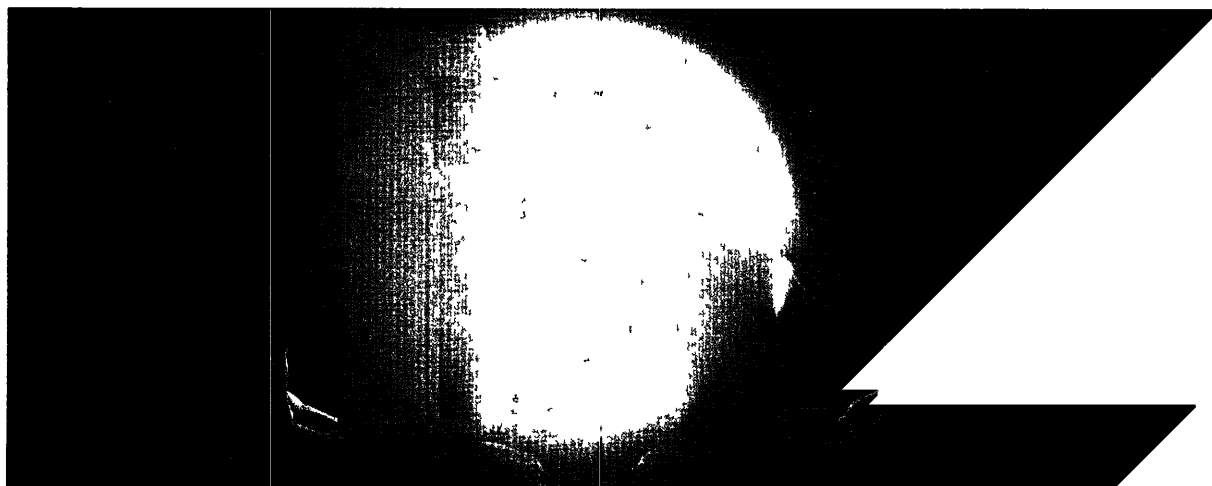

Yaskawa AC Servo Drives with absolute encoder have been developed as basic mechatronics drives for the most advanced FA and FMS, including robots and machine tools. In addition, Σ series has been newly developed.

This manual covers AC servo drive Σ series for speed (torque) control. AC Servo Drives consist primarily of AC SERVOMOTORS and their controllers, SERVOPACKS. The AC SERVOMOTOR features a high power rating for achieving quick response. Custom LSI and hybrid ICs built in SERVOPACK reduce the unit size and simplify wiring. The additional feature of a highly accurate pulse resolution offers non-stop pulse flow.

For your mechatronics systems, the flexible combination of our AC SERVOMOTOR and SERVOPACK achieves stable control operation with high accuracy, quick response control under any environmental condition, and easy maintenance by display/protective functions.

FEATURES

- (1) Highest power rating and fastest response in the class
- (2) For SGM SERVOMOTORS
1/3 the size and weight of conventional models
For SGD SERVOPACKS
1/4 the size of conventional models
- (3) Both incremental and absolute encoders available in a base-mounted SERVOPACK
- (4) Easily operated with an auto tuning function
- (5) High performance with a speed control range of 1 : 5000 realized
- (6) Number of wires between the motor and the encoder is reduced from 15 to 9 (with incremental encoder)
- (7) Can be installed under any environmental condition due to varnish coating

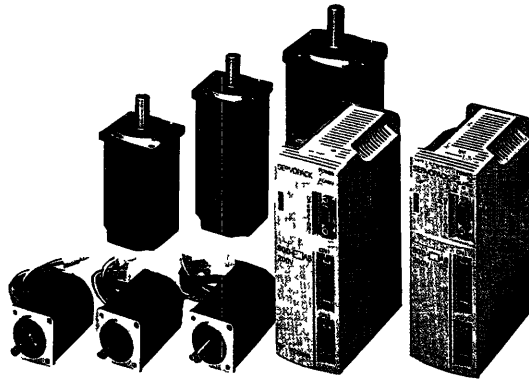

CONTENTS

	Page
1 RATINGS AND SPECIFICATIONS	1
1 1 RATINGS AND SPECIFICATIONS OF SGM SERVOMOTORS (200 VAC)	1
1 1 1 Ratings and Specifications	1
1 1 2 Torque-Speed Characteristics	3
1 2 RATINGS AND SPECIFICATIONS OF SGM SERVOMOTORS (100 VAC)	4
1 2 1 Ratings and Specifications	4
1 2 2 Torque-Speed Characteristics	5
1 3 RATINGS AND SPECIFICATIONS OF SGD SERVOPACKS	6
2 TYPE DESIGNATION	8
2 1 OUTLINE OF SYSTEM	8
2 2 TYPE DESIGNATION	8
3 LIST OF STANDARD COMBINATION	10
4 CHARACTERISTICS	11
4 1 OVERLOAD CHARACTERISTICS	11
4 2 STARTING AND STOPPING TIME	12
4 3 ALLOWABLE FREQUENCY OF OPERATION	13
4 4 SERVOMOTOR FREQUENCY	15
4 5 MOTOR SPEED-REFERENCE INPUT CHARACTERISTICS (Only at speed control mode)	15
4 6 MOTOR MECHANICAL CHARACTERISTICS	16
4 6 1 Mechanical Strength	16
4 6 2 Allowable Radial Load and Thrust Load	16
4 6 3 Mechanical Specifications	16
4 6 4 Direction of Rotation	17
4 6 5 Impact Resistance	18
4 6 6 Vibration Resistance	18
4 6 7 Vibration Class	18
5 CONFIGURATION	19
5 1 CONNECTION DIAGRAM	19
5 2 EXTERNAL TERMINALS	20
5 3 APPLICABLE RECEPTACLES	20
5 3 1 1CN (Connector for I/O Signals)	20
5 3 2 2CN (Connector for Encoder)	20
5 4 CONNECTION (WITH INCREMENTAL ENCODER)	21
5 4 1 Connection Diagram	21
5 4 2 Connector 1CN for I/O Signals	22
5 5 CONNECTION (WITH ABSOLUTE ENCODER)	28
5 5 1 Connection Diagram	28
5 5 2 Connector 1CN for I/O Signals	29
5 6 OUTPUT CIRCUIT	33
5 6 1 Encoder (PG) Output Circuit	33

CONTENTS (Cont'd)

	Page
5 7 CONNECTOR TO TERMINAL CONVERSION UNIT FOR 1CN (PERIPHERAL DEVICES FOR SGD SERVOPACK).....	35
5 8 CONNECTOR 2CN FOR OPTICAL ENCODER	36
5 8 1 Connector 2CN Layout	36
5 8 2 Cable Specifications.....	37
5 8 3 Connection	38
6 OPERATION.....	39
6 1 POWER ON AND OFF	39
6 2 SPEED REFERENCE	41
6 2 1 Speed Reference Circuit	41
6 2 2 Stop Reference Circuit	42
6 2 3 Changing Rated Reference Voltage (± 2 to ± 10 V)	43
6 2 4 Speed Control with Zero Clamp	43
6 2 5 Soft Start Function	43
6 2 6 Jog Operation	44
6 2 7 External Setting Speed Control	44
6 3 TORQUE CONTROL MODE	45
6 3 1 Torque Control I	45
6 3 2 Torque Control II (Torque Control with Speed Limit + Speed Control)	47
6 4 USE OF 12-BIT ABSOLUTE ENCODER	49
6 4 1 Absolute Data Contents	50
6 4 2 Output Signal Processing Circuit	51
6 4 3 Absolute Data Receive	51
6 4 4 Serial Data Specification for 12-bit Absolute Encoder Phase-A (PAO)	52
6 4 5 Serial Data Specification for Phase-S (PSO) No. of Rotations	53
6 4 6 Incremental Pulse	54
6 4 7 SEN Signal	55
6 4 8 Battery	56
6 4 9 Setup Method for 12-bit Absolute Encoder	57
6 4 10 Alarm Output of the 12-bit Absolute Encoder	58
6 4 11 Alarm Code Serial Output	62
6 5 PROTECTIVE FUNCTIONS	63
6 5 1 Dynamic Brake Function	63
6 5 2 Alarm Detection Functions	64
6 5 3 Servo Alarm Output (ALM, ALM-SG)	65
6 5 4 Protective Circuit Operation	65
6 5 5 Resetting Servo Alarm	65
6 6 DISPLAY	65
6 7 PRECAUTIONS FOR APPLICATION	66
6 7 1 Overhanging Loads	66
6 7 2 Load Inertia J_L	67
6 7 3 Regenerative Unit (Peripheral Device for SGD SERVOPACK)	68
6 7 4 High Voltage Line	69
6 8 PRECAUTIONS OF OPERATION	70
6 8 1 Noise Control	70
6 8 2 Power Line Protection	73

CONTENTS (Cont'd)

	Page
6 9 APPLICATION	74
6 9 1 Connection for Reverse Motor Running	74
6 9 2 Holding Brake Interlock Signal	75
7 USER CONSTANTS	76
8 DIGITAL OPERATOR (TYPES JUSP-OP02A-1, 03A)	85
8A DIGITAL OPERATOR (TYPE JUSP-OP02A-1) OPERATION METHOD	85
8A 1 SWITCH OPERATION	85
8A 2 DIGITAL OPERATOR FUNCTIONS	86
8A 3 STATUS INDICATION MODE	87
8A 4 SETTING MODE	88
8A 4 1 User Constant (Data) Setup and Monitor (Cn-03 to Cn-23)	88
8A 4 2 User Constant (Memory Switch) Setup and Monitor (Cn-01 and Cn-02)	89
8A 4 3 Digital Operator Jog Operation Mode Selection and Operating Procedure	90
8A 4 4 Speed Reference Offset Adjustment	92
8A 4 5 Clearing Fault Traceback Data	93
8A 4 6 Speed Reference Offset Manual Adjustment	94
8A 4 7 Check of Motor Parameters	96
8A 4 8 Auto Tuning	98
8A 4 9 Check of Software Version	102
8A 5 MONITOR MODE	104
8A 6 FAULT TRACEBACK MODE	106
8B DIGITAL OPERATOR (TYPE JUSP-OP03A) OPERATION METHOD	108
8B 1 SWITCH OPERATION	108
8B 2 DIGITAL OPERATOR FUNCTIONS	109
8B 3 STATUS INDICATION MODE	110
8B 4 SETTING MODE	111
8B 4 1 User Constant (Data) Setup and Monitor (Cn-03 to Cn-23)	111
8B 4 2 User Constant (Memory Switch) Setup and Monitor (Cn-01 and Cn-02)	113
8B 4 3 Digital Operator Jog Operation Mode Selection and Operating Procedure	114
8B 4 4 Speed Reference Offset Adjustment	116
8B 4 5 Clearing Fault Traceback Data	117
8B 4 6 Speed Reference Offset Manual Adjustment	118
8B 4 7 Check of Motor Parameters	120
8B 4 8 Auto Tuning	122
8B 4 9 Check of Software Version	126
8B 5 MONITOR MODE	128
8B 6 FAULT TRACEBACK MODE	130
9 INSTALLATION AND WIRING	132
9 1 RECEIVING	132
9 2 INSTALLATION	132
9 2 1 SGM SERVOMOTOR	132
9 2 2 SGD SERVOPACK	133
9 3 WIRING	135

CONTENTS (Cont'd)

	Page
9 3 1 Rated Current Cable Size	135
9 3 2 Wiring Precautions	137
9 3 3 Power Consumption	137
10 OUTSIDE DIMENSIONS	138
10 1 SGM SERVOMOTOR	138
10 2 SGD SERVOPACK	162
10 3 REGENERATIVE UNIT	163
10 4 DIGITAL OPERATOR	164
10 5 CABLES	165
10 5 1 When Provided by YASKAWA	165
10 5 2 When Connector on SERVOPACK Side is Provided by User	167
10 5 3 Cable without Connector	169
10 6 CONNECTOR KIT	171
10 7 NOISE FILTER	173
10 8 PERIPHERAL DEVICES	174
11 TEST RUN	176
11 1 CHECK ITEMS BEFORE TEST RUN	176
11 1 1 SGM SERVOMOTOR	176
11 1 2 SGD SERVOPACK	176
11 2 TEST RUN PROCEDURES	176
11 2 1 Preparation for Operation	176
11 2 2 Operation	177
11 2 3 Inspection during Test Run	177
12 ADJUSTMENT	178
12 1 CHARACTERISTICS PRESET AT THE FACTORY PRIOR TO SHIPMENT	178
12 2 RESET	179
13 INSPECTION AND MAINTENANCE	180
13 1 SGM SERVOMOTOR	180
13 2 SGD SERVOPACK	180
13 3 PRECAUTIONS FOR BATTERY REPLACEMENT	180
14 TROUBLESHOOTING	181
14 1 SGM SERVOMOTOR	181
14 2 SGD SERVOPACK	182
14 2 1 LED Indication (7-segment) for Troubleshooting	182
14 2 2 Examples of Troubleshooting for Defective Wiring or Parts	185
14 2 3 Examples of Errors Resulting Setting Errors	185
14 2 4 Cause and Corrective Actions	
No Alarm is Displayed but the Motor does not Run	186

1. RATINGS AND SPECIFICATIONS

1.1 RATINGS AND SPECIFICATIONS OF SGM SERVOMOTORS (200 VAC)

1.1.1 Ratings and Specifications

Time Rating	Continuous	Ambient Humidity	20 to 80% (non-condensing)
Insulation	Class B	Vibration	15 μ m or below
Withstand Voltage	1500 VAC	Excitation	Permanent magnet
Insulation Resistance	. 500 VDC, 10 M Ω or more	Mounting	Flange-mounted
Enclosure	Totally-enclosed, self-cooled	Drive Method	Direct drive
Ambient Temperature	0 to +40°C		

Table 1 1 Ratings and Specifications of SGM SERVOMOTORS (200 VAC)

Motor Type SGM-		A3A	A5A	01A	02A	04A	08A
Rated Output*	W (HP)	30 (0 04)	50 (0 07)	100 (0 13)	200 (0 27)	400 (0 53)	750 (1 01)
Rated Torque*	N m	0 095	0 159	0 318	0 637	1 27	2 39
	(oz in)	(13 5)	(22 6)	(45 1)	(90 1)	(181)	(338)
Instantaneous Peak Torque*	N m	0 29	0 48	0 96	1 91	3 82	7 1
	(oz in)	(40 5)	(67 7)	(135)	(270)	(542)	(1010)
Rated Current*	A (rms)	0 42	0 6	0 87	2 0	2 6	4 4
Instantaneous Max Current*	A (rms)	1 3	1 9	2 8	6 0	8 0	13 9
Rated Speed*	r/min	3000					
Instantaneous Max Speed*	r/min	4500					
Torque Constant*	N · m/A (rms)	0 255	0 286	0 408	0 355	0 533	0 590
	(oz · in/A) (rms)	(36 2)	(40 5)	(57 8)	(50 2)	(75 5)	(83 5)
Moment of Inertia $J_M (= GD^2 M/4)$	kg · m ² × 10 ⁻⁴	0 021	0 026	0 040	0 123	0 191	0 671
	(oz in s ² × 10 ⁻⁷)	(0 288)	(0 368)	(0 576)	(1 74)	(2 70)	(9 52)
Power Rating*	kW/s	4 36	9 63	25 4	32 8	84 6	85 1
Rated Angular Acceleration*	rad/s ²	45200	61200	79500	51800	66600	35600
Inertia Time Constant	ms	1 5	0 9	0 5	0 4	0 3	0 3
Inductive Time Constant	ms	1 5	1 8	1 9	5 4	6 4	13

Notes

- 1 Items marked with * and the torque-speed characteristic are measured when the armature winding combined with the SGD SERVOPACK is 100°C. Other figures are measured when the temperature is 20°C. All the figures are typical values.
- 2 Rated torque is the continuous allowable torque when the motor is mounted to a heat sink of 250 × 250 × 6 (mm) and the ambient temperature is 40°C.
- 3 When shaft seal is mounted on a motor, run the motor at the following derating factor because of increase of friction torque.

SGM-	A3A	A5A	01A	02A	04A	08A
Derating Rate (%)	70	80	90	90	95	95

1.1.1 Ratings and Specifications (Cont'd)

[OPTION]

When options are applied, inertia is increased as shown in the following table
 Characteristics may vary accordingly

Item	Type	SGM-					
		A3A	A5A	01A	02A	04A	08A
With Holding Brake	kg m ² (oz · in · s ²)	0.0085 × 10 ⁻⁴ (0.120 × 10 ⁻³)		0.058 × 10 ⁻⁴ (0.816 × 10 ⁻³)		0.14 × 10 ⁻⁴ (1.98 × 10 ⁻³)	
With 12-bit Absolute Encoder	kg m ² (oz in s ²)	0.025 × 10 ⁻⁴ (0.352 × 10 ⁻³)					

1.1.2 Torque-Speed Characteristics

• TYPE SGM-A3A

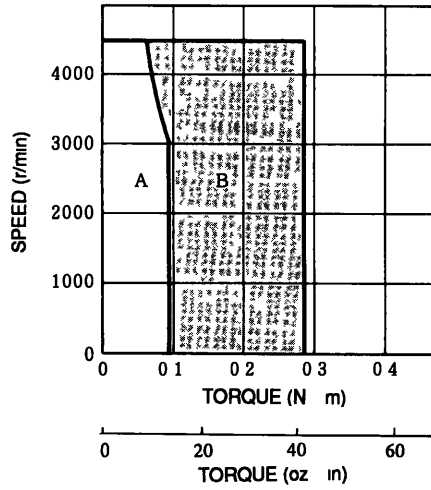

• TYPE SGM-A5A

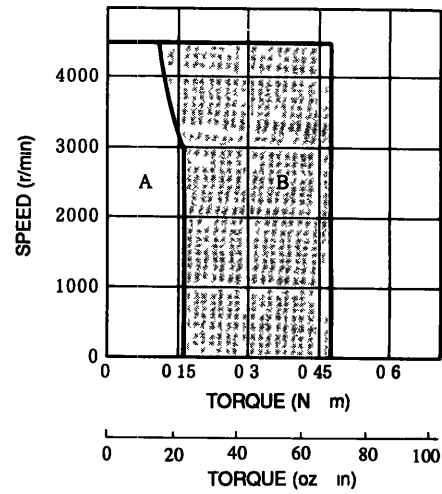

• TYPE SGM-01A

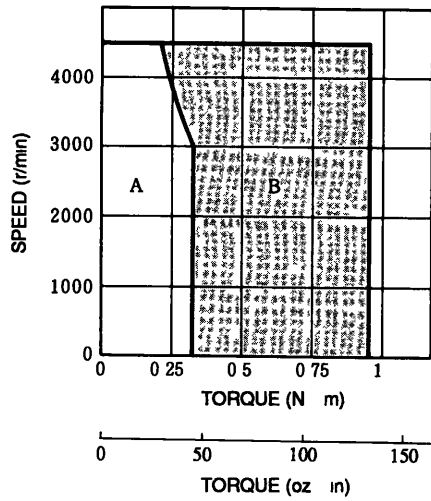

• TYPE SGM-02A

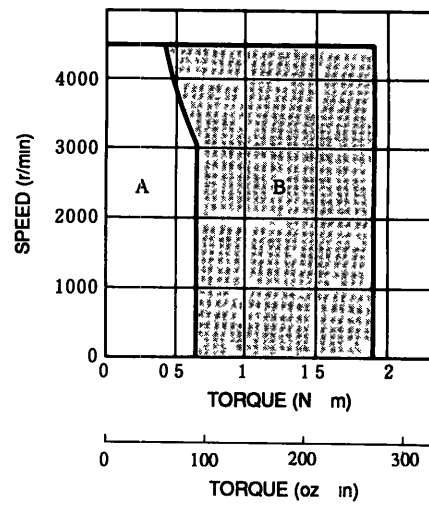

• TYPE SGM-04A

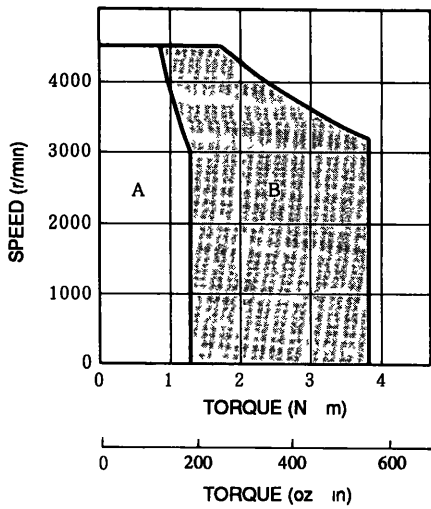

• TYPE SGM-08A

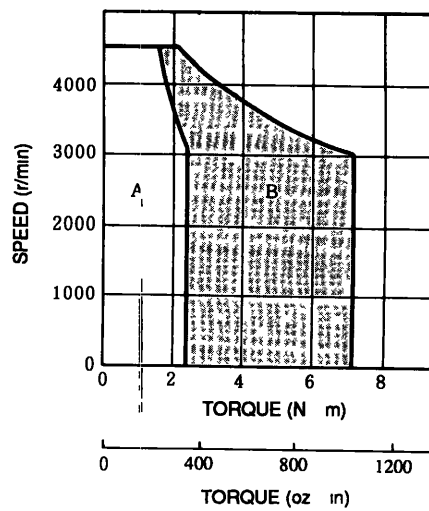

A

CONTINUOUS DUTY ZONE

B

INTERMITTENT DUTY ZONE

1.2 RATINGS AND SPECIFICATIONS OF SGM SERVOMOTORS (100 VAC)

1.2.1 Ratings and Specifications

Time Rating	Continuous	Ambient Temperature	0 to +40°C
Insulation	Class B	Ambient Humidity	20 to 80% (non-condensing)
With stand Voltage	1500 VAC		
Insulation Resistance	500 VDC, 10 MΩ or more	Vibration	15 μm or below
Enclosure	Totally-enclosed, self-cooled	Excitation	Permanent magnet
		Mounting	Flange-mounted
		Drive Method	Direct drive

Table 1.2 Ratings and Specifications of SGM SERVOMOTORS (100 VAC)

Motor Type SGM-		A3B	A5B	01B	02B
Rated Output*	W (HP)	30 (0.04)	50 (0.07)	100 (0.13)	200 (0.27)
Rated Torque*	N·m	0.095	0.159	0.318	0.637
	(oz·in)	(13.5)	(22.6)	(45.1)	(90.1)
Instantaneous Peak Torque*	N·m	0.29	0.48	0.96	1.91
	(oz·in)	(40.5)	(67.7)	(135)	(270)
Rated Current*	A (rms)	0.63	0.9	2.2	2.7
Instantaneous Peak Current*	A (rms)	2.0	2.9	7.1	8.4
Rated Speed*	r/min	3000			
Instantaneous Max Speed*	r/min	4500			
Torque Constant*	N·m/A (rms)	0.168	0.194	0.156	0.255
	(oz·in/A) (rms)	(23.8)	(27.5)	(22.1)	(36.1)
Moment of Inertia	kg·m ² × 10 ⁻⁴	0.021	0.026	0.040	0.123
$J_M (= GD^2 M/4)$	(oz·in·s ² × 10 ⁻³)	(0.288)	(0.368)	(0.576)	(1.74)
Power Rating*	kW/s	4.36	9.63	25.4	32.8
Rated Angular Acceleration*	rad/s ²	45200	61200	79500	51800
Inertia Time Constant	ms	1.6	0.9	0.6	0.4
Inductive Time Constant	ms	1.3	1.6	1.6	5.7

Notes

- Items marked with * and the torque-speed characteristic are measured when the armature winding combined with the SGD SERVOPACK is 100°C. Other figures are measured when the temperature is 20°C. All the figures are typical values.
- Rated torque is the continuous allowable torque when the motor is mounted to a heat sink of 250 × 250 × 6 (mm) and the ambient temperature is 40°C.
- When shaft seal is mounted on a motor, run the motor at the following derating factor because of increase of friction torque.

SGM-	A3B	A5B	01B	02B
Derating Rate (%)	70	80	90	90

[OPTION]

When options are applied, inertia is increased as shown in the following table
 Characteristics may vary accordingly

Item	Type	SGM-			
		A3B	A5B	01B	02B
With Holding Brake	kg · m ² (oz · in s ²)	0.0085 × 10 ⁻⁴ (0.120 × 10 ⁻³)		0.058 × 10 ⁻⁴ (0.816 × 10 ⁻³)	
With 12-bit Absolute Encoder	kg · m ² (oz · in s ²)	0.025 × 10 ⁻⁴ (0.352 × 10 ⁻³)			

1.2.2 Torque-Speed Characteristics

• TYPE SGM-A3B

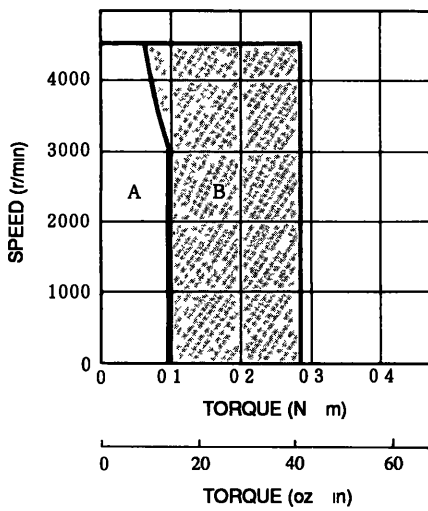

• TYPE SGM-A5B

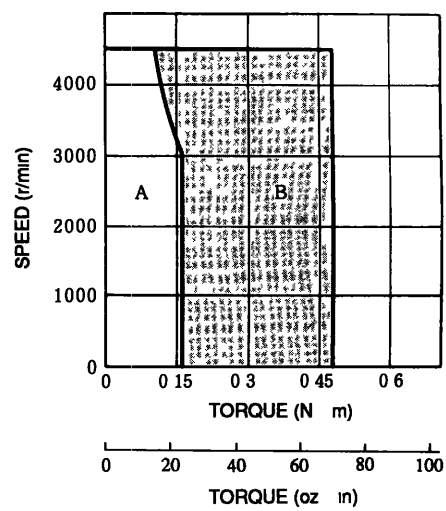

• TYPE SGM-01B

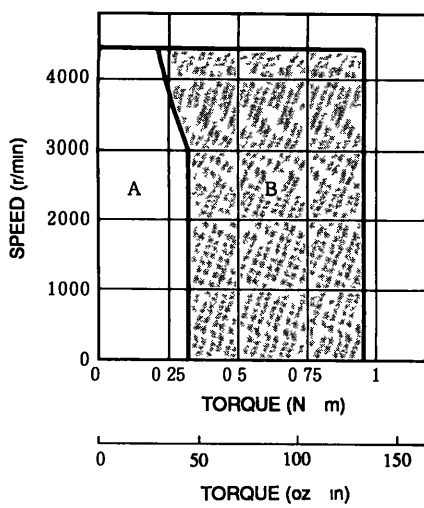

• TYPE SGM-02B

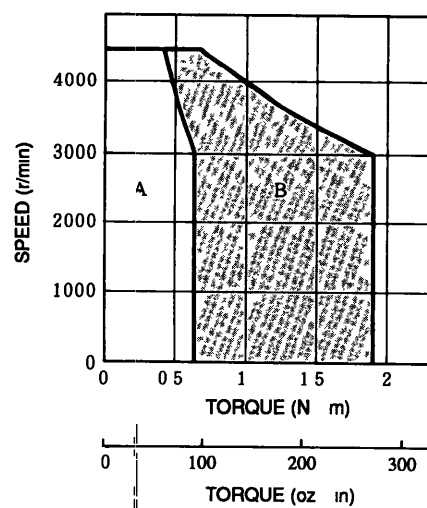

A . CONTINUOUS DUTY ZONE
B . INTERMITTENT DUTY ZONE

1.3 RATINGS AND SPECIFICATIONS OF SGD SERVOPACKS

Table 1 3 Ratings and Specifications of SGD SERVOPACKS

Applied Voltage		200 VAC						100 VAC				
SERVOPACK Type SGD-		A3AS	A5AS	01AS	02AS	04AS	08AS	A3BS	A5BS	01BS	02BS	
Max Motor Capacity W (HP)		30 (0 04)	50 (0 07)	100 (0 13)	200 (0 27)	400 (0 53)	750 (1 01)	30 (0 04)	50 (0 07)	100 (0 13)	200 (0 27)	
Applicable SERVOMOTORS	Type SGM-	A3A	A5A	01A	02A	04A	08A	A3B	A5B	01B	02B	
	Motor Capacity W	30	50	100	200	400	750	30	50	100	200	
	Rated/Max Rotation Speed	3000/4500 r/min						3000/4500 r/min				
	Applicable Encoder	Incremental encoder 2048P/R, absolute encoder 1024P/R										
	Allowable Load Inertia*1	$\text{kg} \cdot \text{m}^2 \times 10^{-4}$ JL (oz in $\text{s}^2 \times 10^{-3}$)	0 63 (8 80)	0 78 (11 0)	1 20 (17 0)	3 69 (52 2)	3 82 (54 1)	13 4 (189)	0 63 (8 80)	0 78 (11 0)	1 20 (17 0)	3 69 (52 2)
	Continuous Output Current A (rms)		0 42	0 60	0 87	2 0	2 6	4 4	0 63	0 90	2 2	2 7
	Max Output Current A (rms)		1 3	1 9	2 8	6 0	8 0	13 9	2 0	2 9	7 1	8 4
Basic Specifications	Power Supply	Single-phase 200 to 230 VAC, +10 to -15%, 50/60 Hz						Single phase 100 to 115 VAC*2 +10 to -15%, 50/60 Hz				
	Control Method	Single-phase full-wave rectifier IGBT-PWM (Sine-wave drive)										
	Feedback Pulse	Incremental encoder 2048P/R, absolute encoder 1024P/R										
	Location	Ambient Temp	0 to 55°C*3									
		Storage Temp	-20 to +85°C									
		Ambient and Storage Humidity	90% or less (non-condensing)									
		Vibration/ Shock Resistance	0 5/2 G									
	Structure	Base-mounted										
	Approx Mass kg (lb)	0 9 (1 98)				1 2 (2 65)		1 5 (3 31)		0 9 (1 98)		1 2 (2 65)
	Speed Control	Speed Control Range*4	1 5000									
Speed Regulation*		Load	0 to 100% 0 01% or less (at rated r/min)									
		Voltage	0%									
		Temperature	25±25°C ±0 1% or less (at rated r/min)									
Frequency Characteristics		150 Hz (at JL = JM)										
Torque Control Repeatability		±2 0%										
Accel/Decel Time Setting	0 to 10 s											
Input Signal	Speed Reference	Rated Reference Voltage	±6 VDC (forward run at plus reference) at rated r/min (factory setting) Variable Setting Range ±2 to ±10 VDC at rated r/min									
		Input Impedance	Approx 30 kΩ									
		Circuit Time Constant	Approx 47 μs									
	Torque Reference	Rated Reference Voltage	±3 VDC (forward run at plus reference) at rated torque (factory setting) Variable Setting Range ±1 to ±10 VDC at rated torque									
		Input Impedance	Approx 30 kΩ									
		Circuit Time Constant	Approx 47 μs									
I/O Signals	Position Output	Output Form	A-, B- C- phase, line driver									
		Freq Dividing Ratio	(16 to N)/N, N = 2048, 1024*6									
	Sequence Input	Servo ON, P drive (or torque control, zero-clamp drive, internal setting speed), forward overtravel (P-OT), reverse overtravel (N-OT), current limit/select (or internal speed select), alarm reset										
	Sequence Output	TGON (or current limit detection), speed coincidence brake interlock, servo alarm alarm code (3 bits)										

Table 1 3 Ratings and Specifications of SGD SERVOPACKS (Cont'd)

Applied Voltage	200 VAC							100 VAC			
SERVOPACK Type	SGD-	A3AS	A5AS	01AS	02AS	04AS	08AS	A3BS	A5BS	01BS	02BS
Max Motor Capacity	W (HP)	30 (0 04)	50 (0 07)	100 (0 13)	200 (0 27)	400 (0 53)	750 (1 01)	30 (0 04)	50 (0 07)	100 (0 13)	200 (0 27)
Dynamic Brake	Operated at main power OFF, servo alarm overtravel										
External Regenerative Unit	Required when exceeding the allowable load inertia * 1										
Overtravel	DB Stop or deceleration stop										
Protective Function	Overcurrent, grounding fault overload overvoltage, overspeed, reference input read error overrun prevention, origin error, CPU error encoder error										
Indication	Alarm LED power ON										
	Digital operation is available as an option										
Others	Torque control, zero-clamp (position loop close) drive, soft start/stop speed coincidence, brake interlock signal output, reverse run connection, JOG run auto tuning										

*1 The allowable load inertia specifies the range requiring no optional regenerative unit. Allowable load inertia is 30 times the motor rotor inertia for 30W to 200W classes, 20 times for 400W and 750W classes. If a load inertia over the specified allowable value is to be applied, use a regenerative unit or operations may be limited.

*2 Supply voltage should not exceed 230V +10% (253V) or 115V+10% (127V). If the voltage should exceed these values, a step-down transformer is required.

*3 When housed in a panel, the internal temperature must not exceed ambient temperature range.

*4 In the speed control range, the lowest speed is defined as the condition in which there is 100% load variation but not stopped.

*5 Speed regulation is generally defined as follows:

$$\text{Speed regulation} = \frac{\text{No load speed} - \text{Full load speed}}{\text{Rated speed}} \times 100 (\%)$$

Motor speed may be changed by voltage variation or operational amplifier drift due to temperature. The ratio of this speed change to the rated speed represents the speed regulation due to voltage or temperature change.

*6 "N" shows the number of encoder pulses.

2. TYPE DESIGNATION

2.1 OUTLINE OF SYSTEM

- SGD SERVOPACK

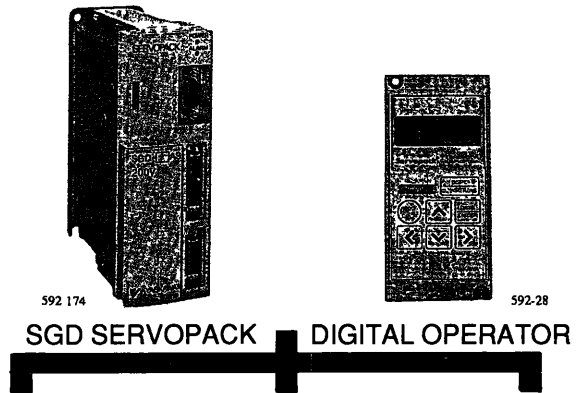

- SGM SERVOMOTOR

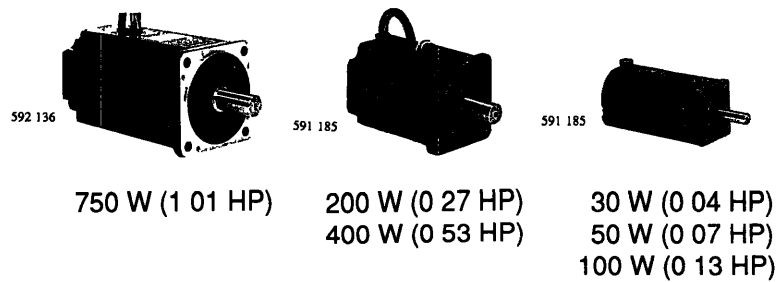

2.2 TYPE DESIGNATION

(1) SGM SERVOMOTOR

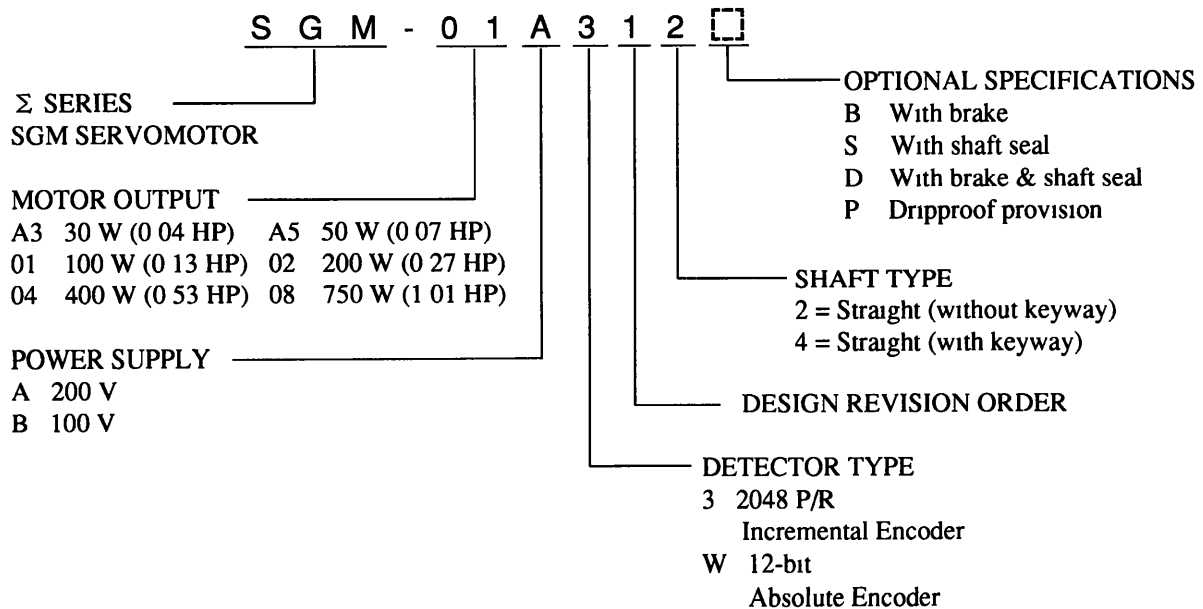

(2) SGD SERVOPACK

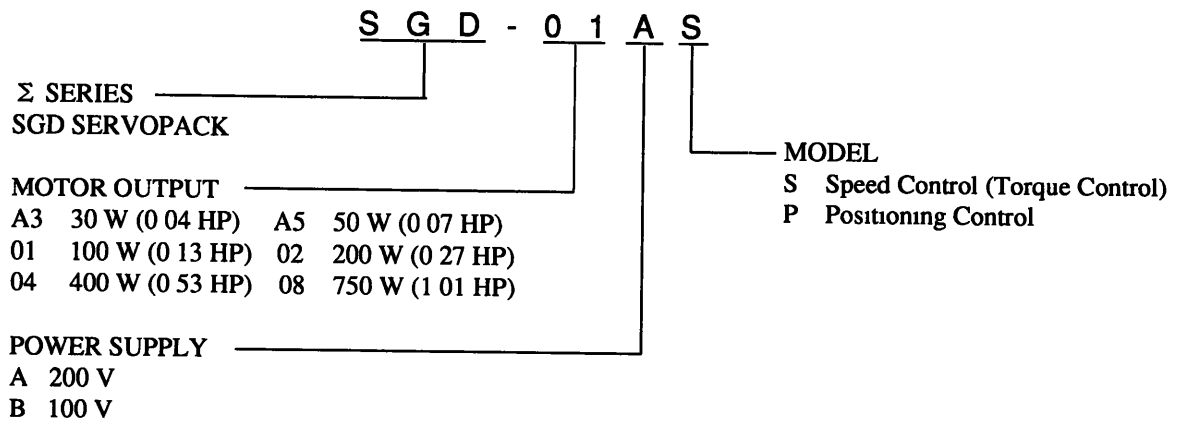

(3) DIGITAL OPERATOR

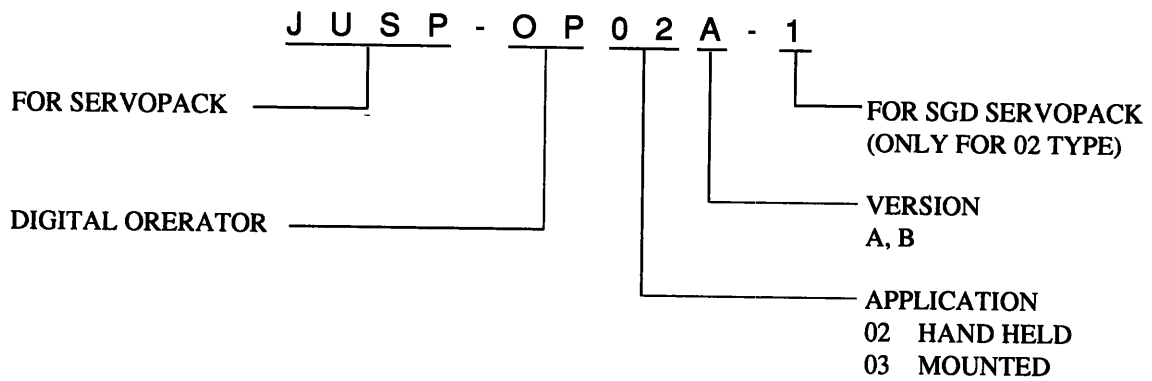

3. LIST OF STANDARD COMBINATION

Table 3 1 Combination of SGM SERVOMOTOR, SGD SERVOPACK and Accessories

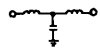
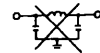
CLASS	SERVOPACK Type SGD-		SERVOMOTOR Type SGD-	Power Capacity per SERVOPACK* ¹ kVA	Current Capacity per MCCB or Fuse* ² A	Applicable Noise Filter	Recommended* ³ Noise Filter		Power ON/OFF Switch
	Type	Model	Model				Type	Specification	
200 VAC	30 W (0 04 HP)	A3AS	A3A	0 25	5	(Good) 	LF-205A	Single-phase 200 VAC Class 5 A	Contactor 30 A or above
	50 W (0 07 HP)	A5AS	A5A	0 3					
	100 W (0 13 HP)	01AS	01A	0 5					
	200 W (0 27 HP)	02AS	02A	0 75					
	400 W (0 53 HP)	04AS	04A	1 2	9	LF-210	Single-phase 200 VAC Class 10 A		
	750 W (1 01 HP)	08AS	08A	2 2	16	(Poor) 	LF-220	Single-phase 200 VAC Class 20 A	
100 VAC	30 W (0 04 HP)	A3BS	A3B	0 25	5		LF-205A	Single-phase 200 VAC Class 5 A	
	50 W (0 07 HP)	A5BS	A5B	0 3					
	100 W (0 13 HP)	01BS	01B	0 5					
	200 W (0 27 HP)	02BS	02B	0 75	8		LF-210	Single-phase 200 VAC Class 10 A	

*1 Values at rated load

*2 Overload characteristics (25°C) 200% 2s or more, 700% 0 01s or more

*3 Made by Tokin Corp Contact YASKAWA sales representative for detail

4. CHARACTERISTICS

4.1 OVERLOAD CHARACTERISTICS

The overload protective function built in SGD SERVOPACK prevents the SGM SERVOMOTOR and SGD SERVOPACK from overloading and restricts the allowable conduction time of SGD SERVOPACK (See Fig 4 1)

The overload detection level is set precisely by the hot start conditions at an ambient temperature of 55°C and cannot be changed

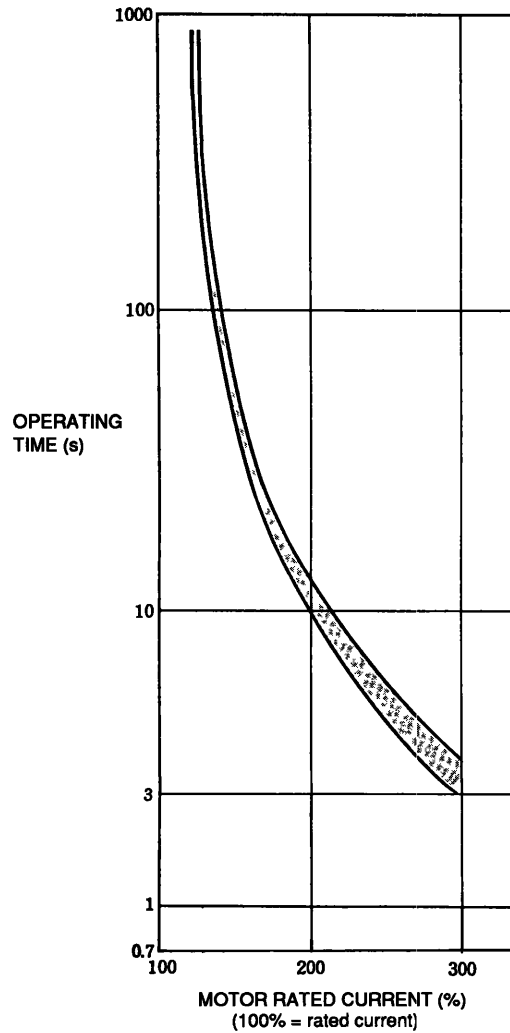

Fig 4 1 Allowable Overload Characteristics of SERVOPACK

4.2 STARTING AND STOPPING TIME

The starting time and stopping time of SERVOMOTOR under a constant load is shown by the formula below. Viscous or friction torque of the motor is disregarded.

Starting Time

$$t_r = 104.7 \times \frac{N_R (J_M + J_L)}{K_t \cdot I_R (\alpha - \beta)} \text{ (ms)}$$

Stopping Time

$$t_f = 104.7 \times \frac{N_R (J_M + J_L)}{K_t \cdot I_R (\alpha + \beta)} \text{ (ms)}$$

Where,

N_R Rated motor speed (r/min)

$J_M (= GD_M^2/4)$ Moment of rotor inertia ($\text{kg} \cdot \text{m}^2 = \text{lb} \cdot \text{in} \cdot \text{s}^2$)

$J_L (= GD_L^2/4)$ Moment of load inertia ($\text{kg} \cdot \text{m}^2 = \text{lb} \cdot \text{in} \cdot \text{s}^2$)

K_t Torque constant of motor ($\text{N} \cdot \text{m}/\text{A} = \text{lb} \cdot \text{in}/\text{A}$)

I_R Motor rated current (A)

$\alpha = I_P / I_R$ Accel/decel current constant

I_P Accel/decel current

(Accel/decel current α times the motor rated current) (A)

$\beta = I_L / I_R$ Load current constant

I_L Current equivalent to load torque

(Load current β times the motor rated current) (A)

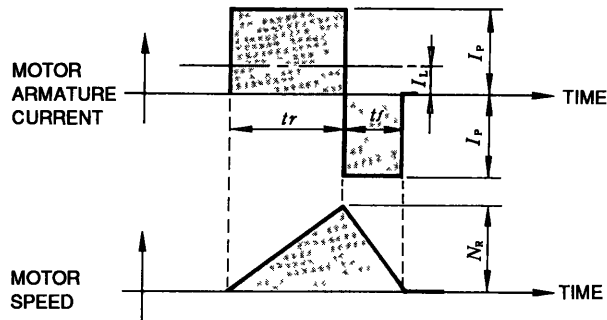

Fig 4 2 Timing Chart of Motor Armature Current and Speed (Constant Load)

4.3 ALLOWABLE FREQUENCY OF OPERATION

The allowable frequency of operation is restricted by the SERVOMOTOR, and the conditions must be considered for satisfactory operation

(1) Allowable Frequency of Operation Restricted by the SERVOMOTOR

The allowable frequency of operation varies depending on the load conditions, motor running time and the operating conditions. Typical examples are shown below. See Par 4 2, "STARTING AND STOPPING TIME" for symbols

·When the motor repeats rated speed operation and being at standstill (Fig 4 3)

Cycle time (T) should be determined so that RMS value of motor armature current is lower than the motor rated current

$$T \geq \frac{I_p^2 (tr + tf) + I_L^2 ts}{I^2_R} \text{ (s)}$$

Where cycle time (T) is determined, values I_p , tr , tf satisfying the formula above, should be specified

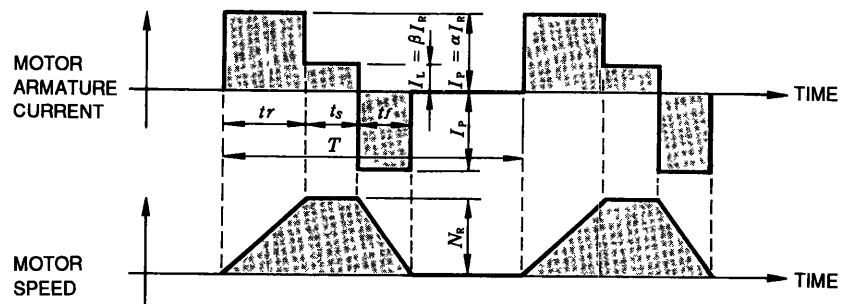

Fig 4 3 Timing Chart of Motor Armature Current and Speed
(Restricted by SERVOMOTOR)

4.3 ALLOWABLE FREQUENCY OF OPERATION (Cont'd)

- When the motor remains at standstill between cycles of acceleration and deceleration without continuous rated speed running (Fig 4 4)

The timing chart of the motor armature current and speed is as shown in Fig 4 4

The allowable frequency of operation "n" can be calculated as follows

$$n = 2865 \times \frac{Kt + I_R}{N_R(J_M + J_L)} \times \left(\frac{1}{\alpha} - \frac{\beta^2}{\alpha^3} \right) \text{ (times/min)}$$

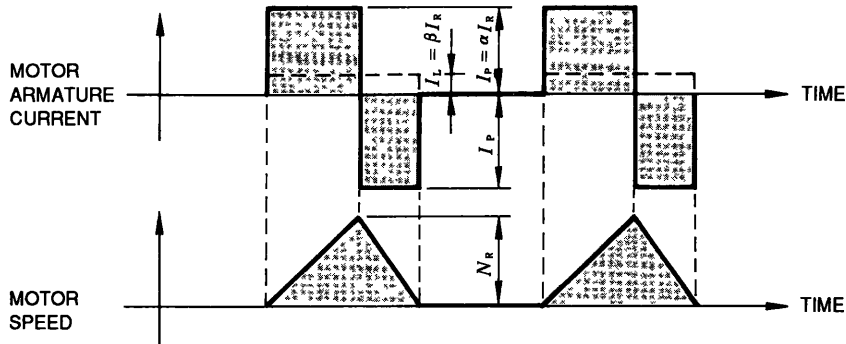

Fig 4 4 Timing Chart of Motor Armature Current and Speed
(The motor remains at standstill between cycles of accel/decel without continuous rated speed running)

- When the motor accelerates, runs at constant speed, and decelerates in a continuing cycle without being at standstill (Fig 4 5)

The timing chart of the motor armature current and speed is as shown in Fig 4 5

The allowable frequency of operation "n" can be calculated as follows

$$n = 2865 \times \frac{Kt + I_R}{N_R(J_M + J_L)} \times \left(\frac{1}{\alpha} - \frac{\beta^2}{\alpha} \right) \text{ (times/min)}$$

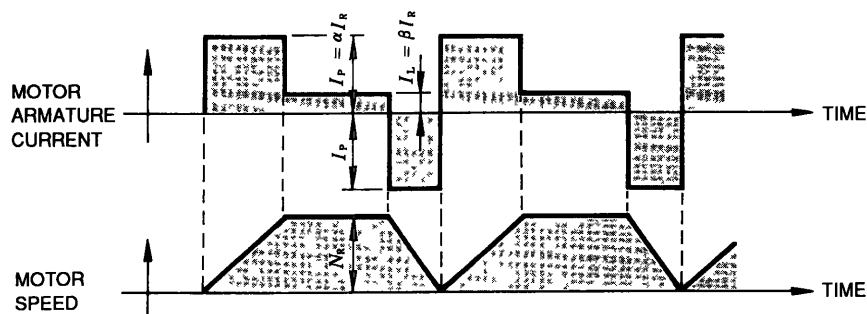

Fig 4 5 Timing Chart of Motor Armature Current and Speed
(The motor accelerates, runs at constant speed, and decelerates in a continuing cycle without being at standstill)

4.4 SERVOMOTOR FREQUENCY

In the servo drive consisting of SERVOPACK and SERVOMOTOR, motor speed amplitude is restricted by the maximum armature current controlled by SERVOPACK

The relation between motor speed amplitude (N) and frequency (f) is shown by the formula below

$$N = 152 \times \frac{\alpha K_t \cdot I_R}{(J_M + J_L) f} \quad (\text{r/min})$$

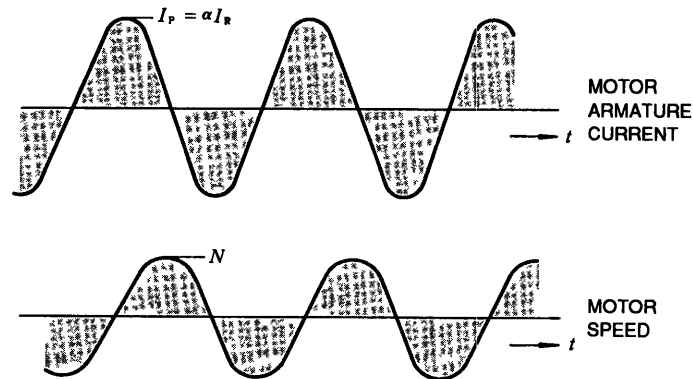

Fig 4 6 Timing Chart of Motor Armature Current and Speed
(Restricted by the maximum armature current)

4.5 MOTOR SPEED-REFERENCE INPUT CHARACTERISTICS (Only at speed control mode)

Fig 4 7 shows motor speed and input voltage curve when speed reference input terminals 1CN-③ and -④ are used. Reference input voltage for rated rotation speed (3000 r/min) can be set by adjusting SERVOPACK user constant Cn-03. For user constant, See Par 7, "USER CONSTANT "

The forward motor rotation (+) means counterclockwise (CCW) rotation when viewed from the drive end

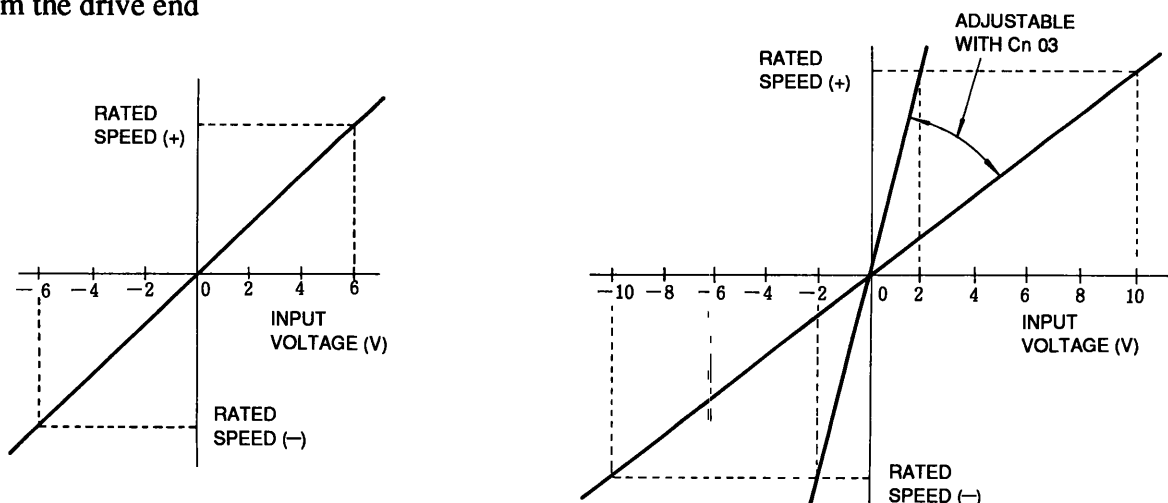

Fig 4 7 Speed-input
Voltage Characteristics

Fig 4 8 Speed-input Voltage Characteristics
when User Constant Cn-03 is Adjusted

4.6 MOTOR MECHANICAL CHARACTERISTICS

4.6.1 Mechanical Strength

SGM SERVOMOTORS can carry momentary maximum torque up to 300% of the rated torque at output shaft

4.6.2 Allowable Radial Load and Thrust Load

Table 4 1 shows allowable loads according to SGM SERVOMOTOR types

Table 4 1 Allowable Radial Load and Thrust Load

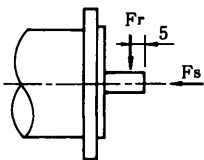
SERVOMOTOR Type	Allowable Radial Load F_r [N (lb)]	Allowable Thrust Load F_s [N (lb)]	Reference Diagram
SGM-A3	49 (11)	19 (4)	
SGM-A5	68 (15)	19 (4)	
SGM-01	68 (15)	19 (4)	
SGM-02	196 (44)	49 (11)	
SGM-04	196 (44)	68 (15)	
SGM-08	343 (77)	98 (22)	

Note Load generated from motor torque plus load applied to the shaft extension never exceed the values mentioned above

4.6.3 Mechanical Specifications

Table 4 2 Mechanical Specifications in mm (inches)

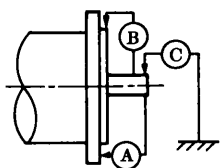
Accuracy (T I R)		Reference Diagram
Flange Surface Perpendicular to Shaft (A)	0.04 (0.0016)	
Flange Diameter Concentric to Shaft (B)	0.04 (0.0016)	
Shaft Run Out (C)	0.02 (0.00079)	

Note T I R (Total Indicator Reading)

4.6.4 Direction of Rotation

SGM SERVOMOTORS rotate counterclockwise (CCW) when viewed from the drive end when motor and detector leads are connected as shown below

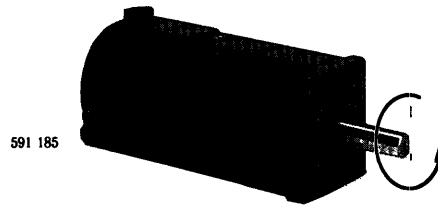

Fig 4 9 SGM SERVOMOTOR

(1) Connector Specifications

• Motor connection
(for standard SERVOMOTOR)



1	Phase-U	Red
2	Phase-V	White
3	Phase-W	Blue
4	FG (Frame ground)	Green

• Motor connection
(for SERVOMOTOR with brake)

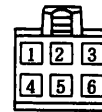

1	Phase-U	Red
2	Phase-V	White
3	Phase-W	Blue
4	FG (Frame ground)	Green
5	Brake terminal	Black
6	Brake terminal	Black

• Detector connection
(incremental encoder)

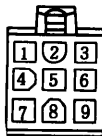

1	Channel A output	Blue
2	Channel \bar{A} output	Blue/Black
3	Channel B output	Yellow
4	Channel \bar{B} output	Yellow/Black
5	Channel C output	Green
6	Channel \bar{C} output	Green/Black
7	0 V (Power supply)	Gray
8	+5 V (Power supply)	Red
9	FG (Frame ground)	Orange

• Detector connection
(absolute encoder)

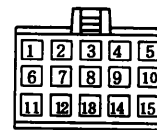

1	Channel A output	Blue
2	Channel \bar{A} output	White/Blue
3	Channel B output	Yellow
4	Channel \bar{B} output	White/Yellow
5	Channel Z output	Green
6	Channel \bar{Z} output	White/Green
7	0 V (Power supply)	Black
8	+5 V (Power supply)	Red
9	FG (Frame ground)	Green/Yellow
10	Channel S output	Purple
11	Channel \bar{S} output	White/Purple
12	Capacity reset	Gray
13	Reset	White/Gray
14	0 V (Battery)	White/Orange
15	3.6 V (Battery)	Orange

4.6.5 Impact Resistance

When mounted horizontally and exposed to vertical shock impulses, the motor can withstand up to two impacts with impact acceleration of 10 G (Fig 4 10)

NOTE

A precision detector is mounted on the opposite-drive end of the SGM SERVOMOTOR. Care should be taken to protect the shaft from impacts that could damage the detector.

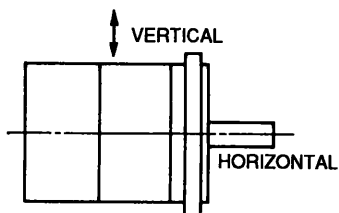

Fig 4 10 Impact Resistance

4.6.6 Vibration Resistance

When mounted horizontally, the motor can withstand vibration (vertical, lateral, axial) of 2.5 G (Fig 4 11)

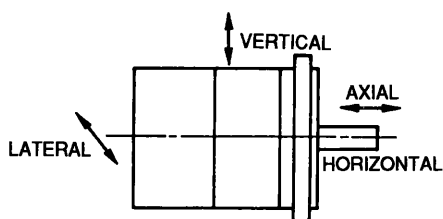

Fig 4 11 Vibration Resistance

4.6.7 Vibration Class

Vibration of the motor running at rated speed is 15 μ m or below (Fig 4 12)

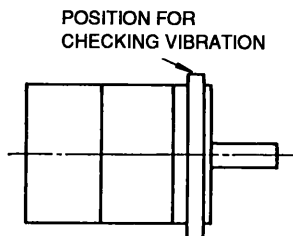

Fig 4 12 Vibration Checking

5. CONFIGURATION

5.1 CONNECTION DIAGRAM

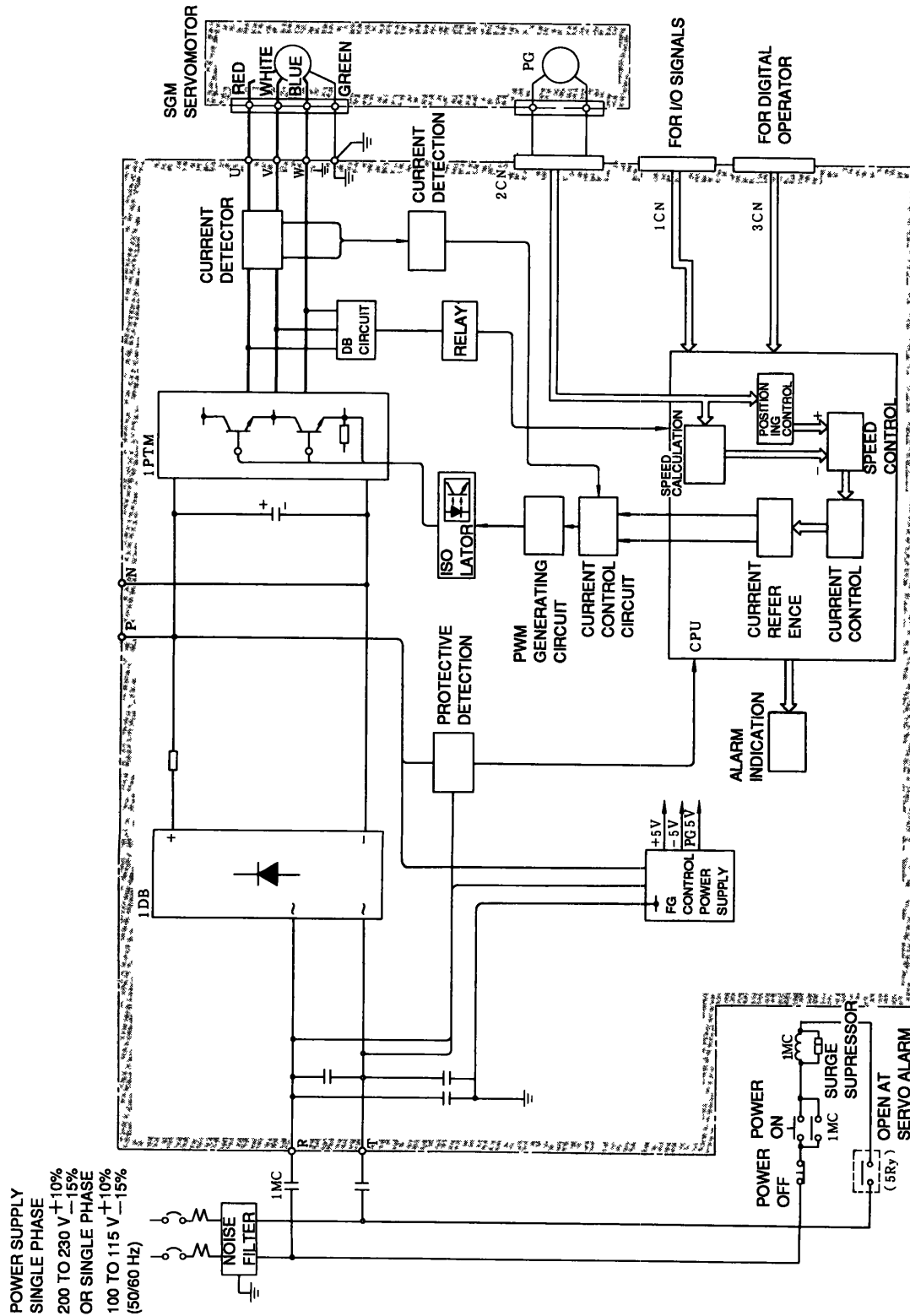

Fig 5 1 Connection Diagram of SGM SERVOPACK (SGD Series)

5.2 EXTERNAL TERMINALS

Table 5 1 External Terminal for SERVOPACK

Terminal Symbol	Name	Description
Ⓜ Ⓣ	Main circuit AC input	Single-phase 200 to 230 VAC $+10\%$ -15% , 50/60 Hz *
Ⓢ Ⓥ Ⓦ	Motor connection	Connects terminal Ⓢ to motor terminal (Red), Ⓥ to (White) and Ⓦ to (Blue)
Ⓧ	Ground	Connects to motor terminal (Green) Must be securely grounded
Ⓟ Ⓝ	Regenerative unit connection	Regenerative unit connection terminal (External connection not normally required)

* For 100 VAC class, single-phase 100 to 115 VAC $+10\%$ -15% , 50/60 Hz is applied

5.3 APPLICABLE RECEPTACLES

5.3.1 1CN (Connector for I/O Signals)

Table 5 2 Specifications of Applicable Receptacles for
SGD SERVOPACK I/O Signals

Connector Type used in SGD SERVOPACK	Applicable Receptacle Type		
	Soldering Type	Case	Manufacturer
10236-52A2JL Right Angle 36P	10136-3000VE	10336-52A0-008	Sumitomo 3M Ltd

5.3.2 2CN (Connector for Encoder)

Table 5 3 Specifications of Applicable Receptacles and Cables

Connector Type used in SGD SERVOPACK	Applicable Receptacle Type			Cable Specifications
	Soldering Type	Case	Manufacturer	
10220-52A2JL Right Angle 20P	10120-3000VE	10320-52A0-008	Sumitomo 3M Ltd	See Par 10 5, "CABLES "

The cables mentioned above are provided by YASKAWA
For details, see Par 10 5, "CABLES "

5.4 CONNECTION (WITH INCREMENTAL ENCODER)

5.4.1 Connection Diagram

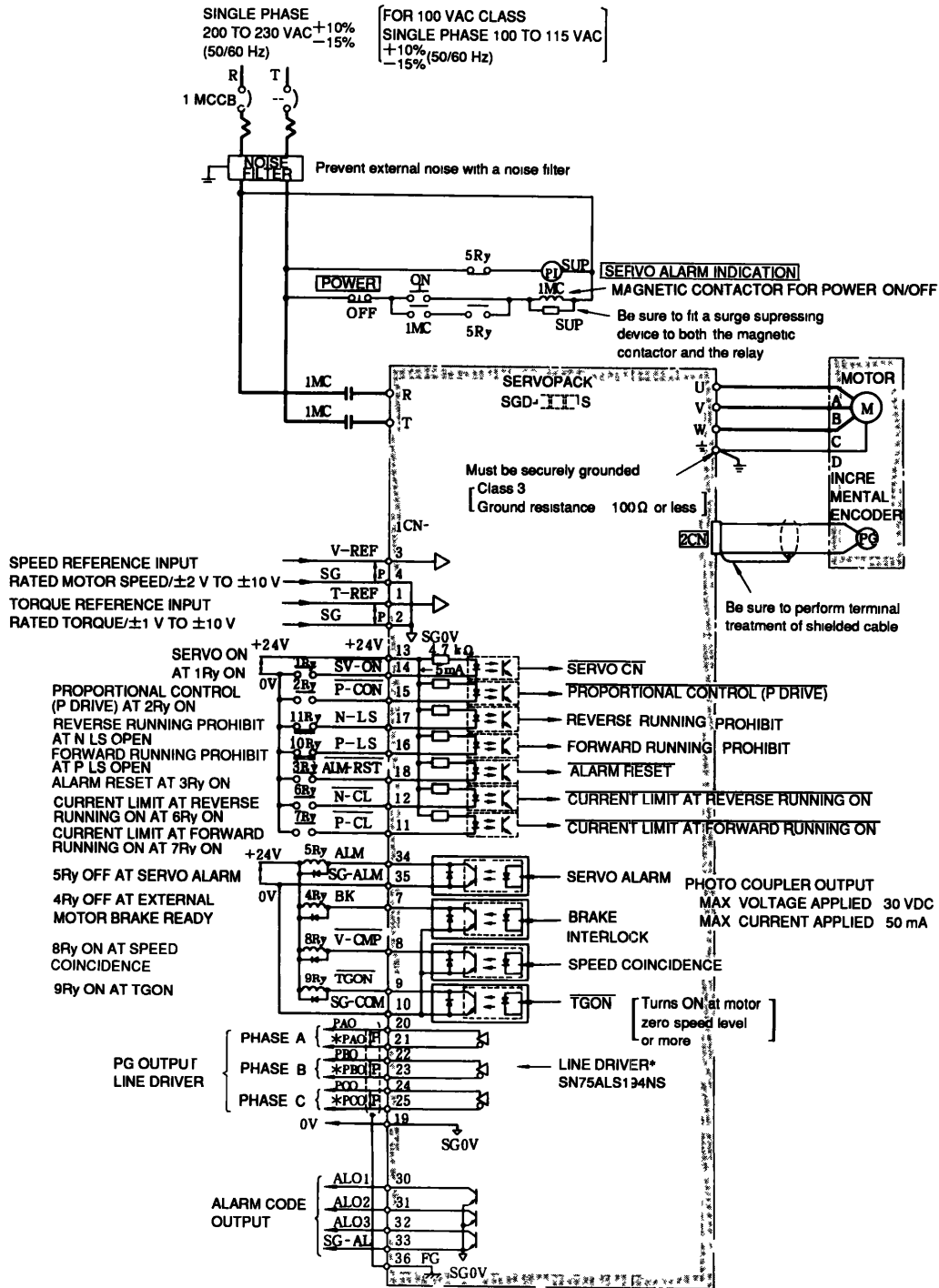

* Made by Texas Instruments Inc

Notes

- 1 Capacity of each output circuit is 30 VDC, 50 mA or less
- 2 \overline{P} Twisted pair wires
- 3 The user must provide the 24 V power supply

Fig 5 2 Example of Connection Diagram of SGD SERVOPACK with a SERVOMOTOR and Peripherals

5.4.2 Connector 1CN for I/O Signals

(1) Connector 1CN Layout

Table 5 4 Connector 1CN Layout of SGD SERVOPACK

2	SG	Torque Reference Input 0V	1	T-REF	Torque Reference Input	20	PAO	PG Output (Phase-A)	19	SG	PG Output Signal 0V
4	SG	Speed Reference Input 0V	3	V-REF	Speed Reference Input	22	PBO	PG Output (Phase-B)	21	*PAO	PG Output (Phase-A)
6			5			24	PCO	PG Output (Phase-C)	23	*PBO	PG Output (Phase-B)
8	$\overline{V-CMP}$	Speed Coincidence Signal Output	7	\overline{BK}	Brake Interlock Signal Output	26			25	*PCO	PG Output (Phase-C)
10	SG-COM	Common 0V to BK, $\overline{V-CMP}$ and TGON	9	\overline{TGON}	TGON Signal Output	28			27		
12	$\overline{N-CL}$	Reverse Current Limit ON Input	11	$\overline{P-CL}$	Forward Current Limit ON Input	30	ALO1	Alarm Code Output	29		
14	$\overline{S-ON}$	Servo ON Input	13	+24 V IN	External Power Input	32	ALO3	Open Collector Output	31	ALO2	Alarm Code Output (Open collector output)
16	P-OT	Forward Prohibit Input	15	$\overline{P-CON}$	P Drive Input	34	ALM	Servo Alarm Output	33	SG-AL	Alarm Code Output Common 0V
18	\overline{ALMRST}	Alarm Reset Input	17	N-OT	Reverse Prohibit Input	36	FG	Frame Ground	35	ALM-SG	Servo Alarm Output

(2) I/O Signals and Connector 1CN

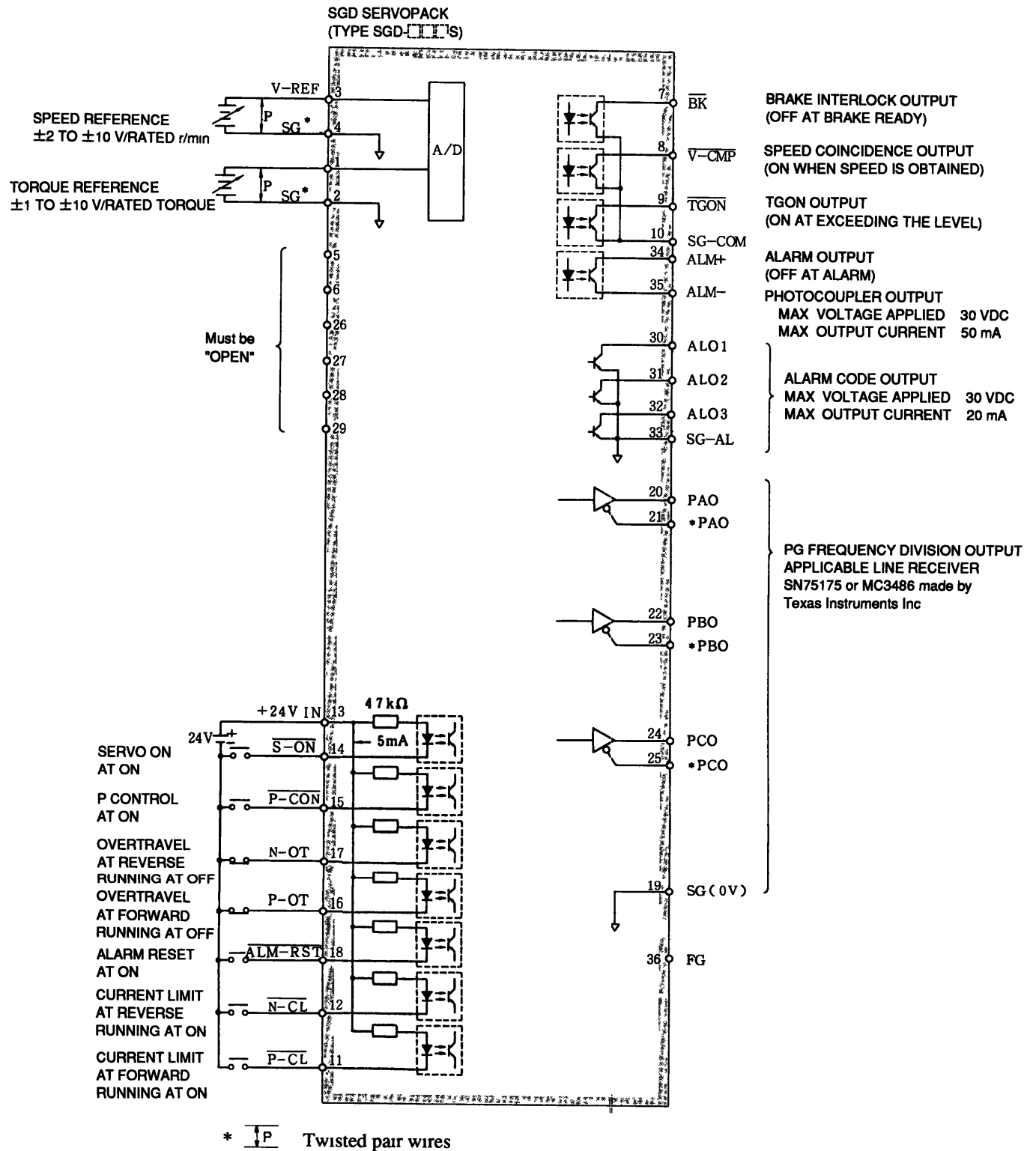

Notes

- 1 Cable for 1CN is not provided
- 2 The user must provide the 24 V power supply

Fig 5 3 I/O Signals Connection and Connector 1CN

(3) Input Signals of Connector 1CN

Table 5 5 Input Signals

Signal Name	Connector 1CN No	Function	Description
$\overline{S-ON}$	14	Servo ON	<ul style="list-style-type: none"> Inputting this signal makes the SERVOPACK ready to receive speed reference inputs Base block and dynamic brake are released When Servo ON signal is not used, this signal can be disabled by setting bit 0 of user constant Cn-01
$\overline{P-CON}$	15	Proportional drive reference	Proportional control command to prevent drifting when the motor is left motionless without command input, while the main circuit is kept energized
		Zero-clamp drive reference	Inputting this signal maintains the motor in Servo lock (stop) status Prevents the motor from drifting
		Torque/speed changeover reference	In torque control II mode, this signal changes torque control to speed control
		External setting speed rotating direction reference	Inputs rotating direction reference at 1st to 3rd speed Used with 1st to 3rd speed selection signal input ($\overline{N-CL}$, $\overline{P-CL}$)
$\overline{N-OT}$	17	Reverse running prohibit	<ul style="list-style-type: none"> In the case of linear drive, etc, connect limit switch signal according to the run direction. This is a normally closed contact This signal can be disabled by setting bit 2 or 3 of user constant Cn-01. Maintains the "$\overline{N-OT}$ at normal run" and "$\overline{P-OT}$ at normal run" status
$\overline{P-OT}$	16	Forward running prohibit	
+24V IN	13	24 V	External power supply for 1CN-11, -12, -14, -15, -16, -17 and 18. Use 24 VDC (50 mA min) power supply
V-REF	3 (4)	Speed reference input	± 2 to ± 10 V/ \pm rated rotation speed is obtained by setting user constant Cn-03 Set to ± 6 V / \pm rated rotation speed prior to being shipped
T-REF	1 (2)	Torque reference input	± 1 to ± 10 V/ \pm rated torque is obtained by setting user constant Cn-13 Set to ± 3 V / \pm rated torque prior to being shipped
$\overline{N-CL}$	12	Current limit at reverse running reference (1st to 3rd speed selection reference)	Current limit reference input or external setting speed (1st to 3rd speed) selection reference input is obtained by setting bit 2 of user constant Cn-02 Current limit value or set speed value is set by user constant
$\overline{P-CL}$	11	Current limit at forward running reference (1st to 3rd speed selection reference)	
\overline{ALMRST}	18	Alarm reset	Resets the servo alarm status

(4) Input Circuit

There are seven kinds of input signals Forward running prohibit, reverse running prohibit, servo ON, proportional drive, overtravel prevention, current limit and alarm reset Construct the input circuit using 24 V power supply (Fig 5 4) Typical circuits are shown in Fig 5 2

NOTE

The user must provide the 24 V power supply
24 ±1 VDC, 50 mA or more (approx 5 mA/circuit)

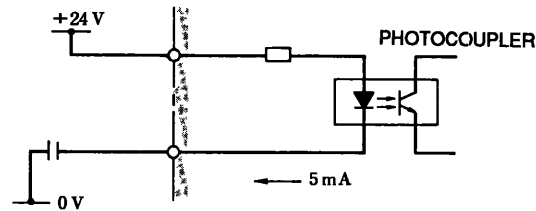

Fig 5 4 Configuration of I/O Circuit

① $\overline{\text{P-CON}}$

This input signal functions as any of the following four signals depending on bits A and B of user constant Cn-01

(a) Proportional drive (P drive)

The drive may drift in open position loop To avoid this, switch the speed amplifier from PI drive to P drive after the positioning and the loop gain in the control system drops and the drift decreases With several percent of friction load, the motor stops completely

(b) Zero clamp operation

After the motor stops, it may be locked electrically This function is applicable vertical loads Continuous operation torque in servo-lock may not exceed 70% of the motor's rated torque

(c) Torque control/speed control changeover

In torque control mode II, this signal switches between torque and speed control

(d) Rotation direction for preset speed reference

Select running direction, if preset speed reference mode is used

② P-OT, N-OT (forward overtravel, reverse overtravel)

These inputs are used to stop the forward running of the motor (counterclockwise when viewed from the drive end of the motor) and reverse running When the overtravel prevention input is not used, connect 1CN- ⑯ and ⑰ to the 0 V of the external 24 V power supply, or invalidate this function by setting bit 2 or 3 of user constant Cn-01

Operation to be performed when an overtravel occurs can be selected from the following four by setting bit 6, 8, or 9 of user constant Cn-01

- (a) Coasting to a stop
When overtravel occurs, the motor coasts to a stop
- (b) DB stop
When overtravel occurs, the motor is stopped by the dynamic brake. The brake is released after the motor stops
- (c) Stop at the torque specified by user constant Cn-06
When overtravel occurs, regardless of speed reference, the internal circuit forcibly changes speed reference to zero and immediately stops the motor. After the motor stops, it is released free
- (d) Zero-clamp after stopping at the torque specified by user constant Cn-06
After the motor stops as (c) above, it is held in zero-clamp mode

③ Servo ON [S-ON]

Turning this signal ON activates the power drive circuit of the SERVOPACK main circuit.

The motor cannot be started unless this signal is input (that is, in the servo-OFF status). When this signal is turned OFF while the motor is rotating, the motor is stopped by the dynamic brake. This signal is automatically input by setting bit 0 of user constant Cn-01

④ P-CL, N-CL

These input signals function as any of the following two signals depending on bit 2 of user constant Cn-02

- (a) External current limit at forward/reverse running reference
A circuit to limit motor armature current max. value during forward (counterclockwise when viewed from the drive end of the motor) or reverse running. The limit value can be specified independently for forward or reverse running by setting user constants Cn-18 and -19.
Regarding the continuous rated output current value as 100%, up to the maximum output current can be specified for the parameters
- (b) Externally set speeds (1st to 3rd) selection reference
The 1st to 3rd speeds are selected according to the inputs as shown in the following tables

Table 5 6

	N-CL	P-CL
1st Speed	ON	OFF
2nd Speed	ON	ON
3rd Speed	OFF	ON
Stop	OFF	OFF

Table 5 7

	P-CON
Forward Running	OFF
Reverse Running	ON

⑤ Alarm reset (ALMRST)

This is an external reset signal for servo alarm. Remove the cause of the alarm before restarting operation. For safety, set a 0 V speed reference when inputting the reset signal.

(5) Output Signals

Table 5 8 Output Signals

Signal Name	Connector 1CN No	Function	Description
ALM	34 (35)	Servo alarm	<ul style="list-style-type: none"> • Goes OFF when fault is detected • For details, see Table 6 6, "Fault Detection Function "
$\overline{\text{TGON}}$ ^{Note}	9 (10)	Rotation detection	Turns ON when the motor rotation speed exceeds the value specified by user constant Cn-0B
$(\overline{\text{CLT}})$ ^{Note}		Current limit detection	<ol style="list-style-type: none"> ① When $\overline{\text{N-CL}}$ or $\overline{\text{P-CL}}$ is ON, this signal turns ON when the torque reaches the lower level value either limited by Cn-18 and Cn-19 or set by Cn-08 and Cn-09 ② When both $\overline{\text{N-CL}}$ and $\overline{\text{P-CL}}$ are OFF, this signal turns ON when the torque set by Cn-08 or Cn-09 is reached
$\overline{\text{BK}}$	7 (10)	Brake interlock output	Output timing signal for external brake signal
$\overline{\text{V-CMP}}$	8 (10)	Speed coincidence output	Turns ON when the difference of motor rotation speed and reference speed (absolute value) is lower than the value set by user constant Cn-22
PAO * PAO PBO * PBO PCO * PCO	20 21 22 23 24 25	PG signal output	Phase-A, $\overline{\text{A}}$ Phase B, $\overline{\text{B}}$ Phase C, $\overline{\text{C}}$
	(19)		
AL01 AL02 AL03	30 31 32	Alarm output code (BCD code)	Open collector output Max voltage applied 30 VDC Max output current 20 mA

Note Select $\overline{\text{TGON}}$ or $\overline{\text{CLT}}$ by setting bit 4 of user constant Cn-01

5.5 CONNECTION (WITH ABSOLUTE ENCODER)

5.5.1 Connection Diagram

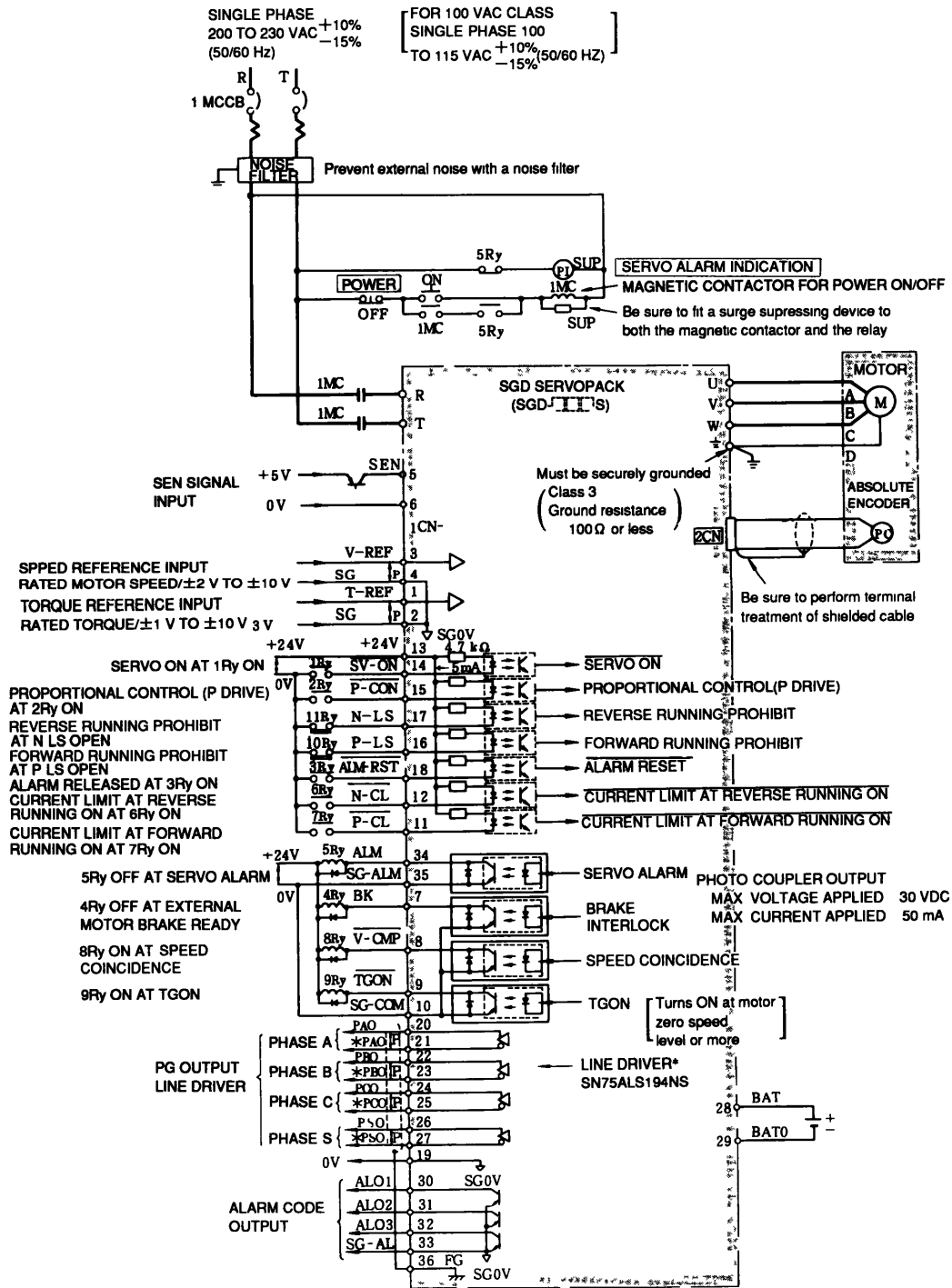

* Made by Texas Instruments Inc

Notes

- Capacity of each output circuit is 30 VDC, 50 mA or less
- TP Twisted pair wires
- The user must provide the 24 V power supply and battery

Fig 5.5 Example of Connection Diagram of SGD SERVOPACK with a SERVOMOTOR and Peripherals (2)

5.5.2 Connector 1CN for I/O Signals

(1) Connector 1CN Layout

Table 5 9 Connector 1CN Layout of SGD SERVOPACK

2	SG	Torque Reference Input 0V	1	T-REF	Torque Reference Input	20	PAO	PG Output (Phase-A)	19	SG	PG Output Signal 0V
4	SG	Speed Reference Input 0V	3	V-REF	Speed Reference Input	22	PBO	PG Output (Phase-B)	21	*PAO	PG Output (Phase-A)
6	0SEN	SEN Signal Output (For absolute encoder only)	5	SEN	SEN Signal Output (For absolute encoder only)	24	PCO	PG Output (Phase-C)	23	*PBO	PG Output (Phase-B)
8	$\overline{V-CMP}$	Speed Coincidence Signal Output	7	\overline{BK}	Brake Interlock Signal Output	26	PSO	PG Output S phase (For absolute encoder only)	25	*PCO	PG Output (Phase-C)
10	SG-COM	Common 0V to \overline{BK} , $\overline{V-CMP}$ and TGON	9	\overline{TGON}	TGON Signal Output	28	BAT	Battery (+) (For absolute encoder only)	27	*PSO	PG Output S phase (For absolute encoder only)
12	$\overline{N-CL}$	Reverse Current Limit ON Input	11	$\overline{P-CL}$	Forward Current Limit ON Input	30	ALO1	Alarm Code Output	29	BAT0	Battery (-) (For absolute encoder only)
14	$\overline{S-ON}$	Servo ON Input	13	+24 V IN	External Power Input	32	ALO3	Open Collector Output	31	ALO2	Alarm Code Output (Open collector output)
16	P-OT	Forward Prohibit Input	15	$\overline{P-CON}$	P Drive Input	34	ALM	Servo Alarm Output	33	SG-AL	Alarm Code Output Common 0V
18	\overline{ALMRST}	Alarm Reset Input	17	N-OT	Reverse Prohibit Input	36	FG	Frame Ground	35	ALM-SG	Servo Alarm Output

(2) I/O Signals and Connector 1CN

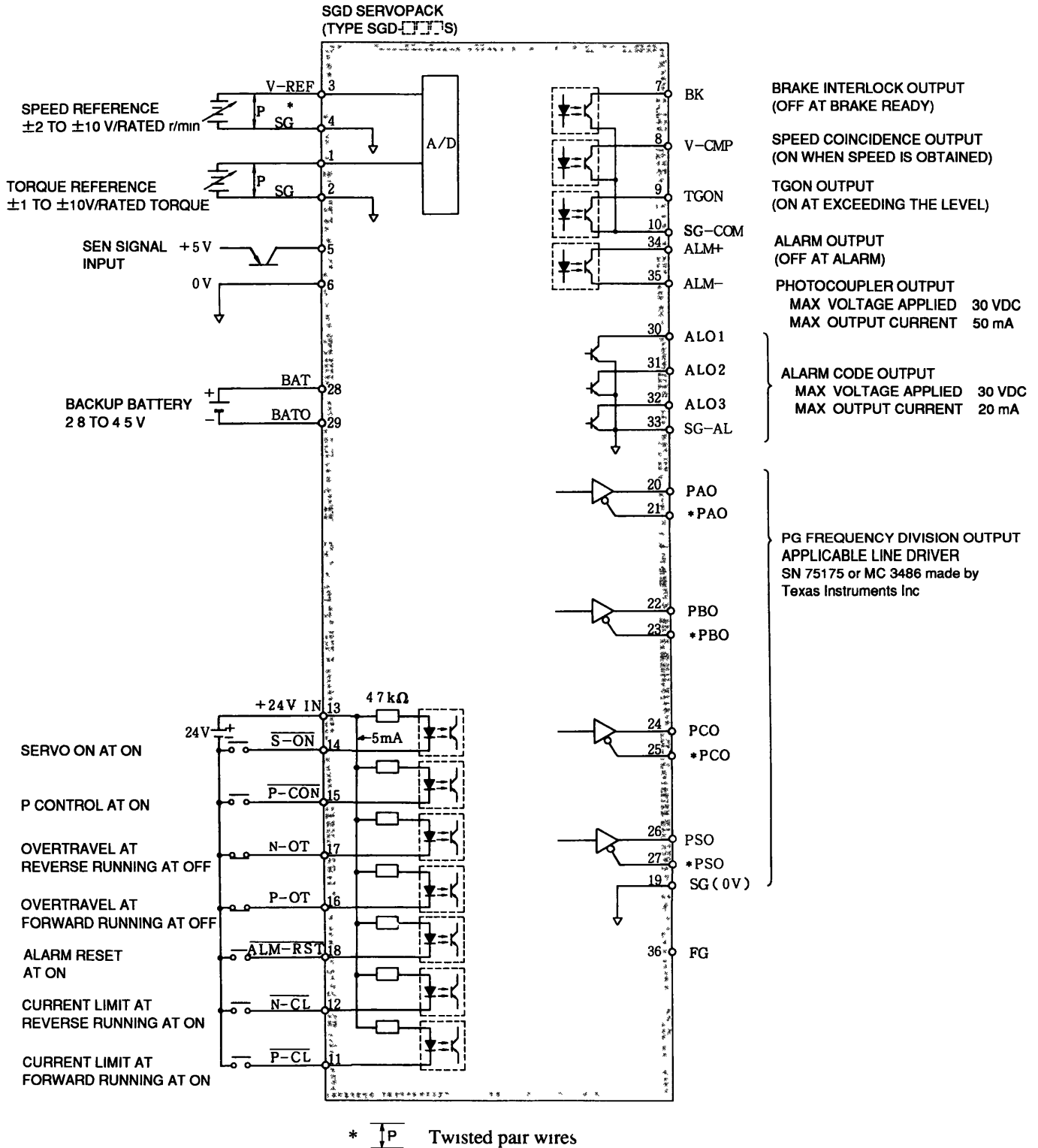

Notes

- 1 Cable for 1CN is not provided
- 2 The user must provide the 24 V power supply

Fig 5.6 I/O Signals Connection and Connector 1CN

(3) Input Signals of Connector 1CN

Table 5 10 Input Signals

Signal Name	Connector 1CN No	Function	Description
$\overline{\text{S-ON}}$	14	Servo ON	<ul style="list-style-type: none"> Inputting this signal makes the SERVOPACK ready to receive speed reference inputs Base block and dynamic brake are cleared When Servo ON signal is not required, this signal can be ineffective by setting bit 0 of user constant Cn-01
$\overline{\text{P-CON}}$	15	Proportional drive reference	Proportional control command applies friction torque to the motor to prevent drifting when the motor is left motionless without command input, while the main circuit is kept energized
		Zero-clamp drive reference	Inputting this signal maintains the motor in servo lock (stop) status Prevent the motor from drifting
		Torque/speed changeover reference	In torque control II mode, inputting this signal changes torque control to speed control
		External setting speed rotating direction reference	Inputs rotating direction reference at 1st to 3rd speed Used with 1st to 3rd speed selection signal input ($\overline{\text{N-CL}}$, $\overline{\text{P-CL}}$)
$\overline{\text{N-OT}}$	17	Reverse running prohibit	<ul style="list-style-type: none"> In the case of linear motion, etc., connect limit switch signal according to the run direction. Since it is a bar signal (reverse signal), it is "Closed" during normal run. When limit switch is tripped, it becomes "Open." This signal can be ineffective by setting bit 2 or 3 of user constant Cn-01. Maintains the "N-OT" at normal run" and "P-OT" at normal run" status
$\overline{\text{P-OT}}$	16	Forward running prohibit	
+24 VIN	13	24 V	External power supply to 1CN-11, -12, -14, -15, -16, -17 and -18. Prepare a 24 VDC (50 mA min) power supply
V-REF	3 (4)	Speed reference input	± 2 to ± 10 V/ \pm rated rotation speed is obtained by setting user constant Cn-03 Set to ± 6 V/ \pm rated rotation speed prior to being shipped
T-REF	1 (2)	Torque reference input	± 1 to ± 10 V/ \pm rated torque is obtained by setting user constant Cn-13 Set to ± 3 V/ \pm rated torque prior to being shipped
$\overline{\text{N-CL}}$	12	Current limit at reverse running reference (1st to 3rd speed selection reference)	Current limit reference input or external setting speed (1st to 3rd speed) selection reference input is obtained by setting bit 2 of user constant Cn-02 Current limit value or set speed value is set by user constant
$\overline{\text{P-CL}}$	11	Current limit at forward running reference (1st to 3rd speed selection reference)	
ALMRST	18	Alarm reset	Resets the servo alarm status
BAT	28	Backup battery positive input	These terminals are for connecting backup battery in case of a power failure of the absolute encoder Applicable voltage is 2.8 to 4.5 V (No battery is provided by YASKAWA)
BAT0	29	Backup battery negative input	
SEN	5 (6)	Sensor ON	Turning this signal from low to high provides +5 V to the absolute encoder, outputs serial data and initial pulse, and starts normal operation. Turning SEN signal from high to low turns OFF power to the absolute encoder

(4) Input Circuit

Input signals are the same as those of the SERVOPACK with incremental encoder
See Par. 5 4.2 (3), "Input Signals of Connector 1CN "

(5) Output Signals

Table 5 11 Output Signals

Signal Name	Connector 1CN No	Function		Description
ALM	34 (35)	Servo alarm		<ul style="list-style-type: none"> Goes OFF when fault is detected For details, see Table 6 6, "Fault Detection Function "
^{Note} TGON	9 (10)	Rotation detection		Turns ON when the motor rotation speed exceeds the value specified by user constant Cn-0B
^{Note} (CLT)		Current limit detection		① When $\overline{N-CL}$ or $\overline{P-CL}$ is ON, this signal turns ON when the torque reaches the lower level value either limited by Cn-18 and Cn-19 or set by Cn-08 and Cn-09 ② When both $\overline{N-CL}$ and $\overline{P-CL}$ are OFF, this signal turns ON when the torque set in Cn-08 or Cn-09 is reached
\overline{BK}	7 (10)	Brake interlock output		Outputs timing signal for external brake signal
$\overline{V-CMP}$	8 (10)	Speed agreed output		Turns ON when the difference of motor rotation speed and reference speed (absolute value) is lower than the value set by user constant Cn-22
PAO * PAO PBO * PBO PCO * PCO	20 21 22 23 24 25	PG signal output	Phase-A, \overline{A}	<ul style="list-style-type: none"> PG pulse after frequency division is output by line driver (SN75ALS194NS made by TI or equivalent) To be received by a line receiver (SN75175 made by TI or equivalent) 1CN-19 is 0V for PG output signal Connect to 0V of the host controller
	(19)		Phase-B, \overline{B}	
			Phase-C, \overline{C}	
PSO * PSO	26 27	PG signal output	Phase-S, \overline{S}	<ul style="list-style-type: none"> This is PG phase-S signal output The cumulative number of motor rotations is continuously output in serial data This signal is output by a line driver (SN75ALS194NS made by Texas Instruments or equivalent) Receive this signal by a line driver (SN75175 made by Texas Instruments or equivalent)
AL01 AL02 AL03	30 31 32	(33) Alarm output code (BCD code)		Open collector output Max voltage applied 30 VDC Max output current 20 mA

Note Select \overline{TGON} or \overline{CLT} by setting bit 4 of user constant Cn-01

5.6 OUTPUT CIRCUIT

There are seven output signals

TGON (or current limit detection), brake interlock, servo alarm, speed coincidence and three alarm codes for open collector output

These output circuits are non-contact, employing transistors. Voltage and current specifications are

Applied Voltage (V Max) ≤ 30 V

Conduction Current (I_p) ≤ 50 mA

For alarm codes 1 to 3, I_p is 20 mA max.

NOTE

The output circuit requires a separate power supply (20 mA max for open collector output). It is recommended to use the same 24 V power supply used for the input circuit (Fig 5.7)

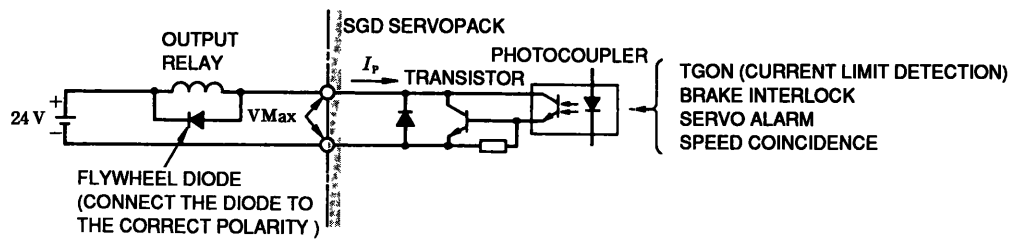

Fig 5.7 Output Circuit

5.6.1 Encoder (PG) Output Circuit

[PAO, *PAO, PBO, *PBO, PCO, *PCO]

Outputs PG phase-A, -B, and -C (reference) signals. Use as position signals. Specifications of output signals are as follows

(1) Signal Form

Two-phase pulse with 90-degree phase difference for phase-A, -B and reference pulse for phase-C

(2) Output Circuit and Receiver Circuit

Output circuit is a line driver output circuit See Fig 5 8

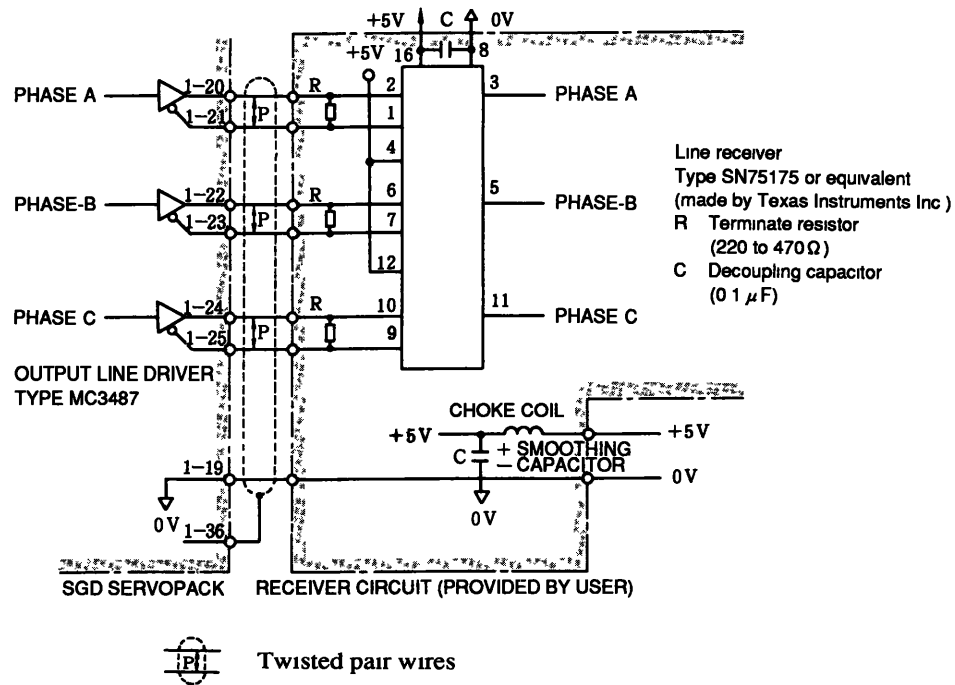
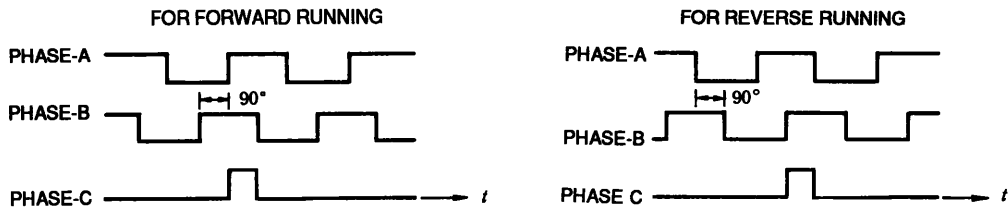

Fig 5 8 Example of Output Circuit and Receiver Circuit

(3) Output Phase (Frequency dividing ratio 1/1)

(a) In case the incremental encoder is applied



(b) In case the absolute encoder is applied

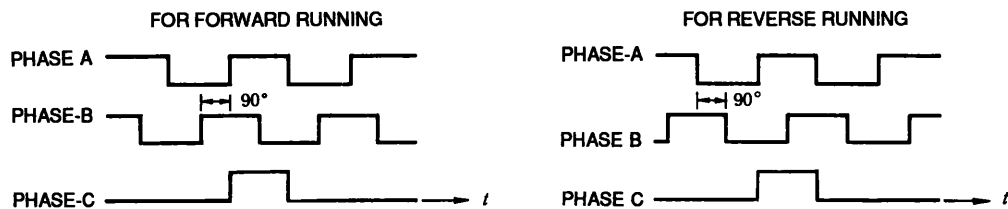

Note For details of frequency dividing, refer to Par 7 (8), "PG Division Ratio Setting "

Fig 5 9 Forward/Reverse Output Phase

5.7 CONNECTOR TO TERMINAL CONVERSION UNIT FOR 1CN (PERIPHERAL DEVICES FOR SGD SERVOPACK)

(1) Application

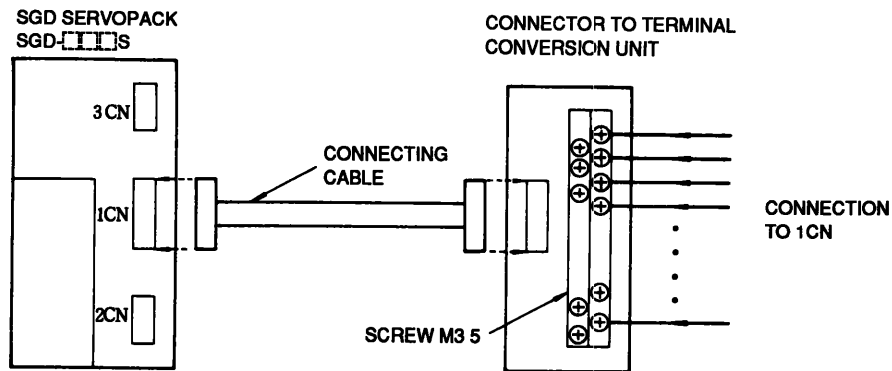

Note Connector to terminal conversion unit for 2CN is not provided Cable for absolute/incremental encoder is available For details, refer to Par 10 5, "CABLES "

(2) Connecting Cable (Accessories for conversion unit JUSP-TA36 □)

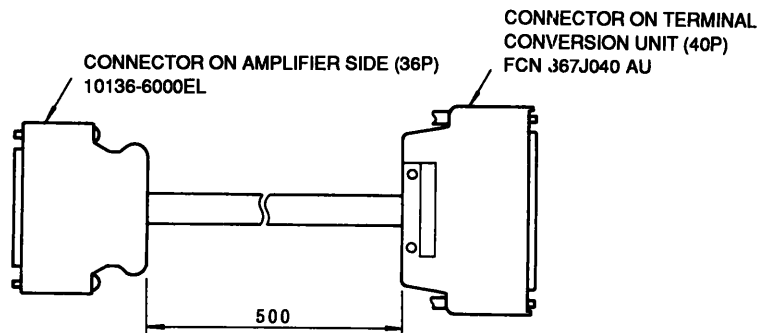

5.8 CONNECTOR 2CN FOR OPTICAL ENCODER

5.8.1 Connector 2CN Layout

Table 5 12 Connector 2CN Layout of SGD SERVOPACK

2	PG0V	PG Power 0 V	1	PG0V	PG Power 0 V	12	BAT +	Battery (+) (For absolute encoder only)	11		
			3	PG0V						13	BAT -
4	PG5V	PG Power 0 V	5	PG5V	PG Power +5V	14	PC	PG Input C-phase	15	*PC	PG Input C-phase
6	PG5V						16	PA	PG Input A-phase	17	*PA
8	PS	PG Input S phase (For absolute encoder only)	7	DIR	Rotating Direction Input	18	PB	PG Input B-phase	19	*PB	PG Input B-phase
10			9	*PS	PG Input S phase (For absolute encoder only)	20	FG	Frame Ground			

5.8.2 Cable Specifications

If required, order in units of standard lengths as shown in Table 5 13

Table 5 13 Cable Specifications

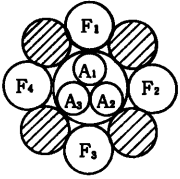
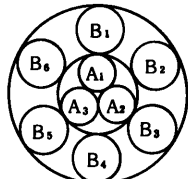
YASKAWA Drawing No	Incremental Encoder B9400064	Absolute Encoder DP8409123				
General Specifications	Double KQVV-SW AWG22 × 3C AWG26 × 4P	Double KQVV-SW AWG22 × 3C AWG26 × 6P				
Finishing Dimensions	φ 7 5 mm (φ 0 30 in)	φ 8 0 mm (φ 0 31 in)				
Recommended Receptacle Type	(Soldered Type) 	(Soldered Type) 				
Internal Composition and Lead Color	A ₁	Red		A ₁	Red	
	A ₂	Black		A ₂	Black	
	A ₃	Green yellow		A ₃	Green yellow	
	F ₁	Bule/White blue	Twisted pair wires	B ₁	Blue/White blue	Twisted pair wires
	F ₂	Yellow/White yellow	Twisted pair wires	B ₂	Yellow/White yellow	Twisted pair wires
	F ₃	Pale green/White pale green	Twisted pair wires	B ₃	Green/White green	Twisted pair wires
	F ₄	Orange/White orange	Twisted pair wires	B ₄	Orange/White orange	Twisted pair wires
				B ₅	Purple/White purple	Twisted pair wires
				B ₆	Gray/White gray	Twisted pair wires
YASKAWA Standard Specifications	Standard lengths 3 m, 5 m, 10 m, 15 m, 20 m*					

* For cables with connectors, see Par 10 5, "CABLES "

Note Allowable wiring distance between SGD SERVOPACK and SGM SERVOMOTOR (PG) is 20 m max Cables must be assembled by authorized vendor with appropriate tooling

5.8.3 Connection

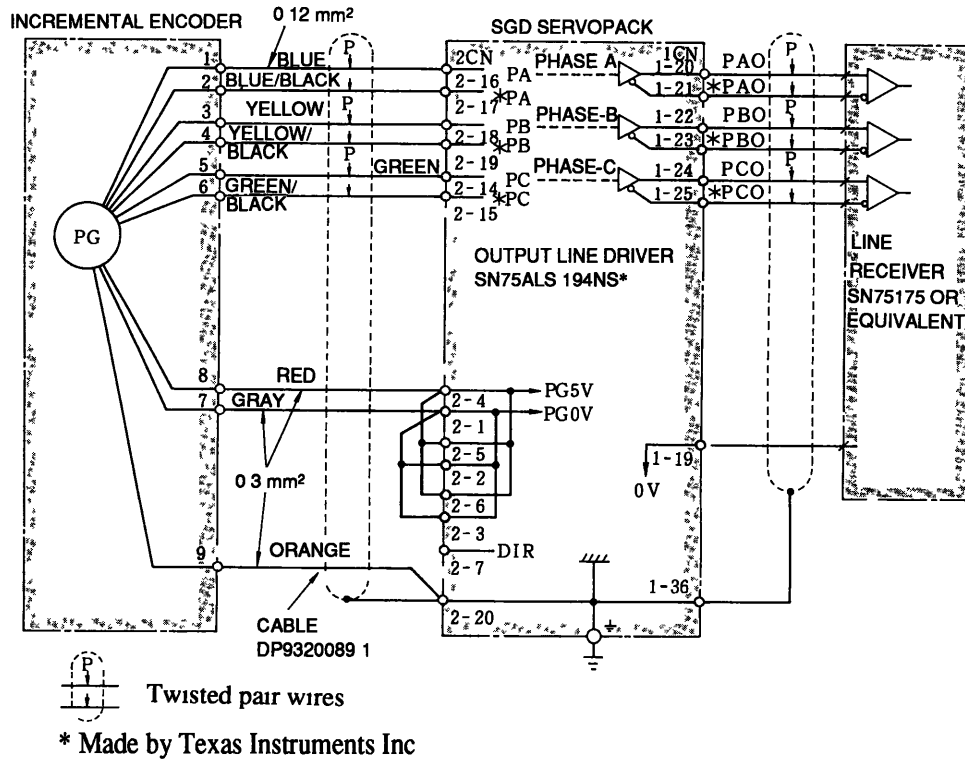

Fig 5 10 Connector 2CN for Incremental Encoder Connection and 1CN Output Processing (When using Connection Cable DP9320089-1)

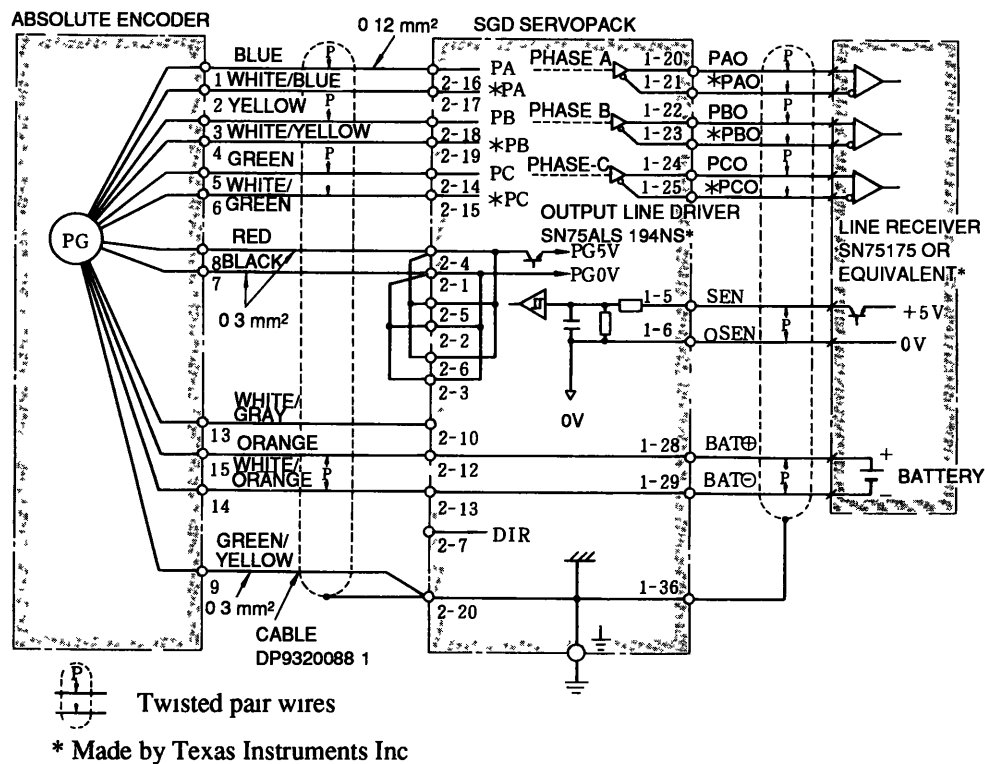
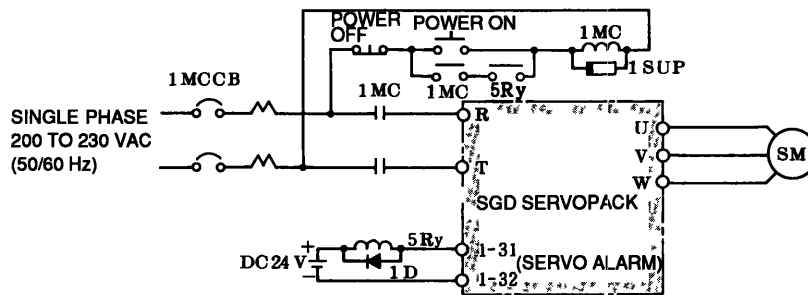

Fig 5 11 Connector 2CN for Absolute Encoder Connection and 1CN Output Processing (When using Connection Cable DP9320088-1)

6. OPERATION

6.1 POWER ON AND OFF

The following diagram (Fig 6 1) shows the sequence example for power ON/OFF



1SUP Surge suppressor

1D Flywheel diode (to prevent 5Ry spike)

Fig 6 1 Connection Example for Power ON/OFF (200 VAC)

Precautions for Connections in Fig 6 1 are as follows

- Make sequence to assure that the main circuit power will be cut OFF by a servo alarm signal

For operation at alarm signal output, refer to Par 6 5 4, "Protective Circuit Operation"

- When power is supplied to the power ON/OFF sequence shown in Fig 6 1, the normal signal is set (5Ry is turned ON) in the control circuit after a maximum delay of 2 seconds

NOTE

When the power is turned ON, a servo alarm signal continues for approximately 2 seconds to initialize the SGD SERVOPACK

- Since SGD SERVOPACK is of a capacitor input type, large in-rush current flows when the main circuit power is turned ON (recharging time 0.2 s) If the power is turned ON and OFF frequently, the in-rush current limit resistor may be degraded and a malfunction may occur When the motor starts, turn ON the speed reference and turn it OFF when the motor stops Do not turn the power ON or OFF
- A momentary power failure may occur when power is supplied again immediately after power turns OFF Make sure to turn ON the power after the time shown below has elapsed

Type	SGD-	A3AS A5AS	01AS 02AS 04AS	08AS	200 V AC input
		A3BS	A5BS 01BS 02BS	—	100 V AC input
Power Holding Time		6 s	10 s	15 s	Max Value

Caution .

High voltage remains for a while in SERVOPACK after power goes OFF

6.2 SPEED REFERENCE

6.2.1 Speed Reference Circuit

From the external power, the speed reference voltage is given to input 1CN-③ and ④
 The method for giving speed reference voltage is shown below

(1) For accurate (inching) speed setting

- 25 HP-10B type Multiple-rotation type, wire wound variable resistor (with dial MD10-30B4) made by Sakae Tsushin Inc

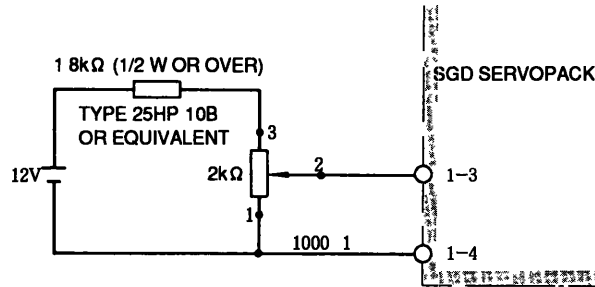

(a) When Multiple-rotation Type, Wire-Wound Variable Resistor is used

- RV30YN type Carbon-film variable resistor made by Tokyo Cosmos Electric
- Low- and high-speed relays Reed relays

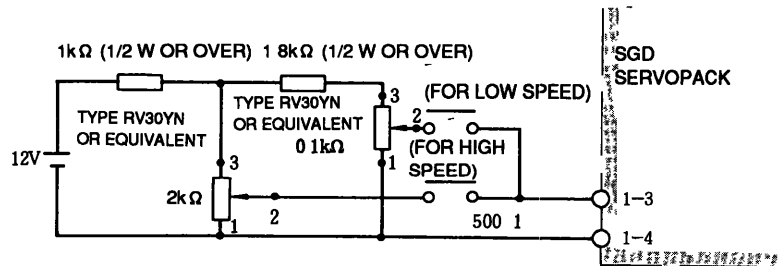

Note When a carbon resistor is used, great residual resistance remains, so the speed control range becomes approximately 500 1

(b) When Carbon Variable Resistor is used

Fig 6 2 Method for Giving Speed Reference Voltage (for Accurate Speed Setting)

(2) For relatively rough speed setting

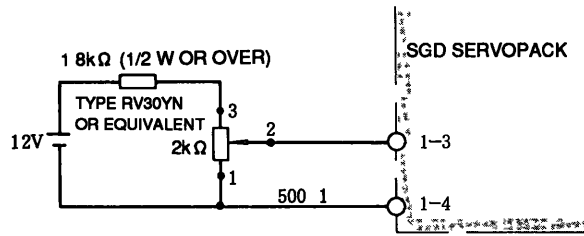

Note When a carbon resistor is used, great residual resistance remains, so the speed control range becomes about 500 1

Fig 6 3 Method for Giving Speed Reference Voltage (for relatively rough speed setting as compared with Fig 6 2)

6.2.2 Stop Reference Circuit

When giving a stop reference, do not open the speed reference circuit (1CN-③), but set to 0 V

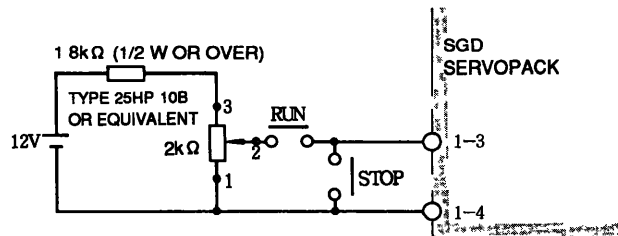

(a) When Multiple-rotation Type, Wire-Wound Variable Resistor is used

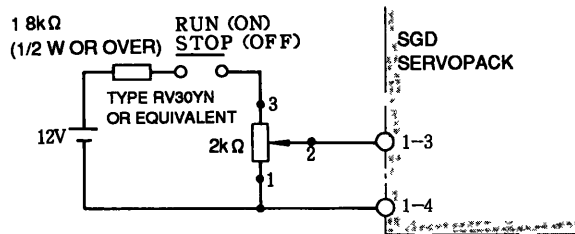

(b) When Carbon Variable Resistor is used

Fig 6 4 Method for Giving Stop Reference

6.2.3 Changing Rated Reference Voltage (± 2 to ± 10 V)

To use at a voltage other than the rated reference voltage ± 6 V, perform the following steps

< Setup procedure >

Using the digital operator (JUSP-OP02A-01 or -OP03A), enter motor rotation speed per volt [(r/min)/V] for user constant Cn-03

(Examples)

- When Cn-03 = 300 Entering 10 V sets 3000 r/min (rated rotation speed)
- When Cn-03 = 600 Entering 5 V sets 3000 r/min (rated rotation speed)

When the machine is to be used with Yaskawa's POSITIONPACK for positioning, set up position loop gain for Cn-03 of the SERVOPACK

6.2.4 Speed Control with Zero Clamp

Speed control with zero clamp mode can be selected by setting bits A and B of user constant Cn-01

In this mode, after motor rotation speed falls below the set value of user constant Cn-0F, speed reference is disregarded and the motor speed is reduced to zero. While the motor is stopped, position loop keeps it in servo-lock status

- Turning ON P-CON signal starts zero-clamp operation
- In zero-clamp speed control mode, P/PI control cannot be switched like usual speed control mode since the P-CON signal is used for turning the zero clamp function ON/OFF signal

6.2.5 Soft Start Function

Motor accel/decel time can be set up

< Setup procedure >

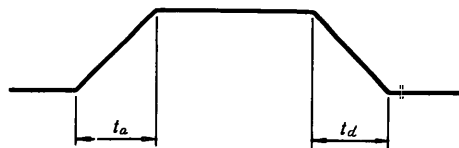

Set the time in milliseconds accelerating to the maximum motor rotation speed (t_a) to user constant Cn-07 and decelerating to stop (t_d) to user constant Cn-23. Make sure to set both user constants Cn-07 and Cn-23.

6.2.6 Jog Operation

The motor can be operated from the digital operator (JUSP-OP02A-1 or -OP03A) without entering speed reference during operation. Jog speed (r/min) can be varied depending on the value set to user constant Cn-10.

6.2.7 External Setting Speed Control

External setting speed control mode can be selected by setting bit 2 of user constant Cn-02.

In this mode, input value (1st to 3rd speeds) specified for user constants Cn-1F to Cn-21 can be used.

To select the speeds, use contact inputs $\overline{\text{P-CL}}$ and $\overline{\text{N-CL}}$. Specify the direction of rotation by $\overline{\text{P-CON}}$ input.

In this mode, the current limit function and the P/PI switch function are unavailable.

6.3 TORQUE CONTROL MODE

In the torque control mode, speed loop is disconnected and the motor is driven by torque reference

In this mode, torque control I or torque control II can be selected by setting bit A or B of user constant Cn-01

6.3.1 Torque Control I

In torque control I, torque reference voltage is applied from external power supply across terminals 1 and 2 of 1CN

3 V/rated torque are preset at the factory prior to shipment. They can be changed by user constant Cn-13

Examples of giving torque reference voltage are shown in the following

(1) For accurate (inching) torque setting

In Figs 6 5 and 6 6, 1-1 and 1-2 are the input terminal number of SERVOPACK

• 25HP-10B type Multiple-rotation type, wire-wound variable resistor (with dial MD10-30B4)

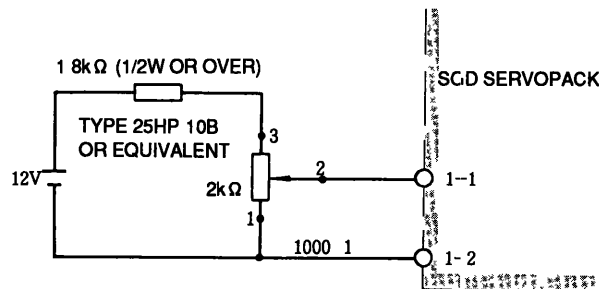

(a) When Multiple-rotation Type,
Wire-Wound Variable Resistor is used

- RV30YN type Carbon-film variable resistor made by Tokyo Cosmos Electric
- Low-and high-speed relays Reed relays

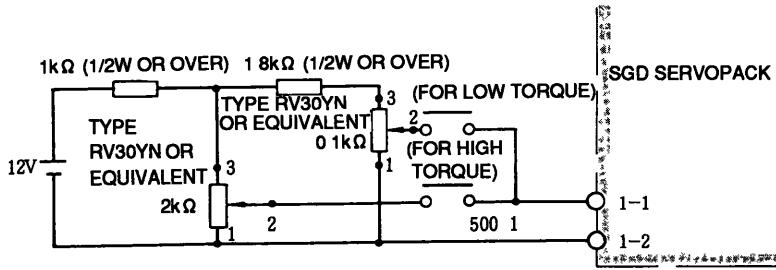

Note When a carbon resistor is used, great residual resistance remains, so the torque control range becomes approximately 500 1

(b) When Carbon Variable Resistor is used

Fig 6.5 Method of Giving Torque Reference Voltage (for accurate torque setting)

(2) For relatively rough torque setting

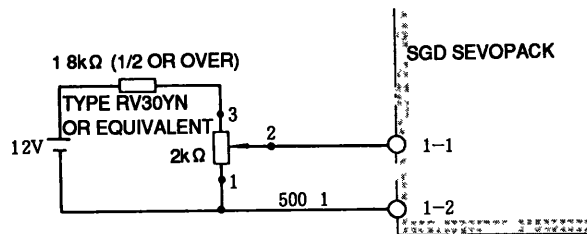

Note When a carbon resistor is used, great residual resistance remains, so the torque control range becomes approximately 500 1

Fig 6.6 Method for Giving Torque Reference Voltage (for relatively rough torque setting)

6.3.2 Torque Control II (Torque Control with Speed Limit + Speed Control)

• In torque control II, torque control is performed along with speed control using the motor speed limit function

Switching from torque control to speed control can be accomplished by turning $\overline{\text{P-CON}}$ signal ON

In torque control II, $\overline{\text{P-CON}}$ signal is used for switching torque control and speed control so that P/PI control cannot be switched like during usual speed control

An external power supply applies torque reference voltage across terminals 1 and 2 of input 1CN, and speed limit voltage (both forward and reverse sides speed limit at positive voltage) across terminals 3 and 4 of input 1CN

3 V/rated torque are preset at the factory prior to shipment

Examples of giving torque reference voltage and speed limit voltage are shown in the following

(1) For accurate (inching) torque or speed limit setting

The input terminal numbers of the SGD SERVOPACK shown in Figs 6 7 and 6 8 are for entering torque reference voltage Terminal numbers in parentheses are for entering speed limit voltage

• 25HP-10B type Multiple-rotation type, wire-wound variable resistor (with dial MD10-30B4)

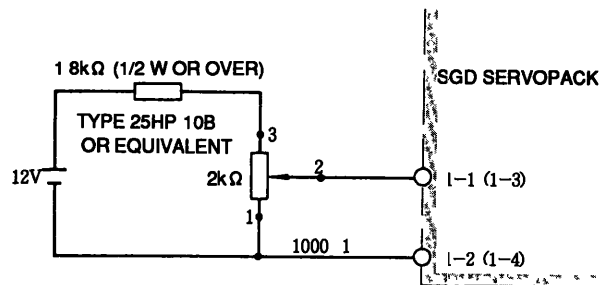

(a) When Multiple-rotation Type, Wire-Wound Variable Resistor is used

- RV30YN type Carbon-film variable resistor made by Tokyo Cosmos Electric
- Low- and high-speed relays Reed relays

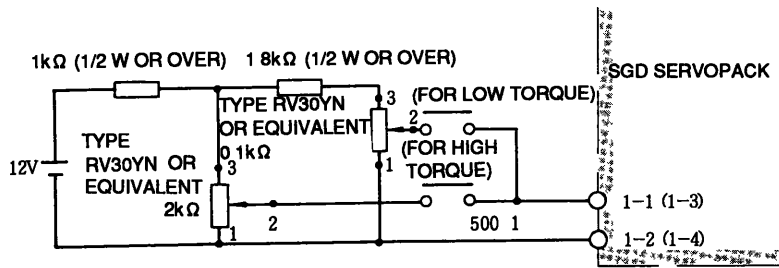

Note When a carbon resistor is used, great residual resistance remains, so the torque control range becomes approximately 500 1

(b) When carbon variable resistor is used

Fig 6.7 Method for Giving Torque Reference/Speed Limit Voltage (for accurate torque or speed limit setting)

(2) For relatively rough torque or speed limit setting

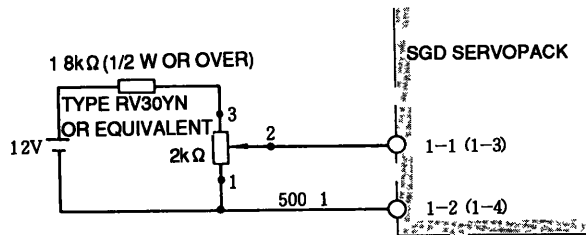

Note When a carbon resistor is used, great residual resistance remains, so the torque control range becomes approximately 500 1

Fig 6.8 Method for Giving Torque Reference/Speed Limit Voltage (for relatively rough torque or speed limit setting)

6.4 USE OF 12-BIT ABSOLUTE ENCODER

The 12-bit absolute encoder outputs PAO, PBO, PCO and PSO are shown below

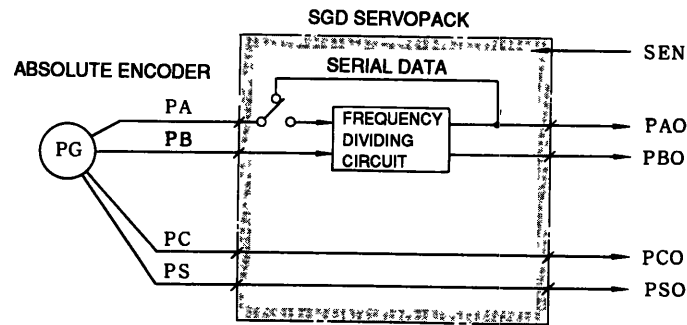

Fig 6 9 Absolute Encoder Output

When SEN signal is input (from a low to high level), absolute data are first output from PAO as serial data, then as initial incremental pulses PAO and PBO (2-phase pulse with 90-degree phase difference)

After this, output operation same as normal incremental encoder (2-phase pulse with 90-degree phase difference) is performed

Number of rotations (serial data) are output from PSO

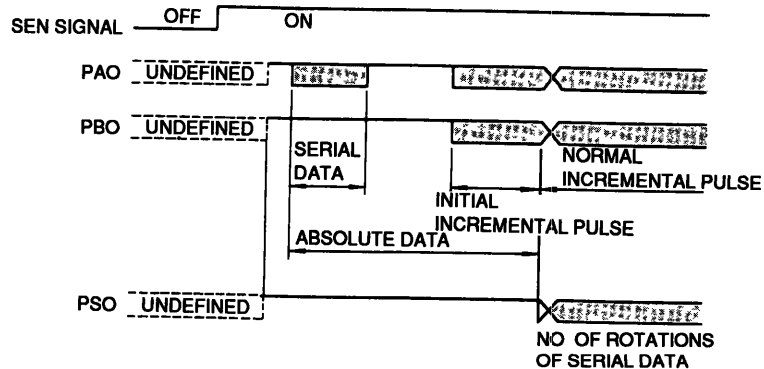

Fig 6 10 Absolute Data Output

6.4.1 Absolute Data Contents

Serial data

Indicates the position of the motor shaft (in terms of revolutions) from the reference position (value set at setup time)

Initial incremental pulse

Pulse is output at the same pulse speed as rotation at approx 4900 r/min from the motor shaft origin position to the current motor shaft position

Assuming that the serial data value is M (revolutions), the initial incremental pulse count value is P_0 (pulses), and the number of output pulses per revolution of the motor (depending on divider circuit setting) is R (P/R), the current position P_E can be found by the expression

$$P_E = M \times R + P_0$$

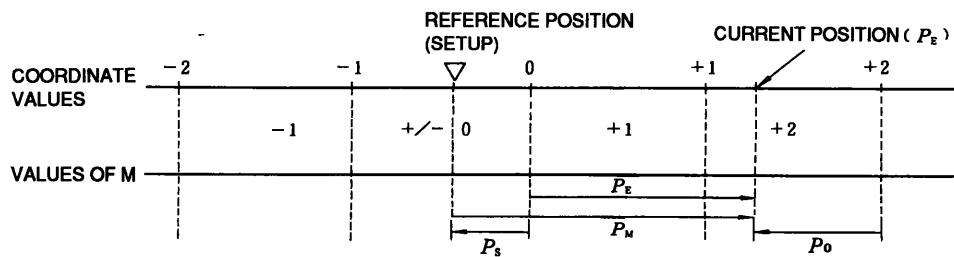

(Example)

P_E Current value read-out from encoder

M Multi-revolution data

P_0 Initial incremental pulses read-out from encoder (Normally, negative value)

P_s Initial incremental pulses read-out at setup point (Normally, negative value
This value is stored and controlled by upper controller)

P_M Current value required in user's system

R Number of pulses (4096 pulses for this encoder)

$$P_E = M \times R + P_0$$

$$P_M = P_E - P_s$$

6.4.2 Output Signal Processing Circuit

The 12-bit absolute encoder output processing circuit as shown below

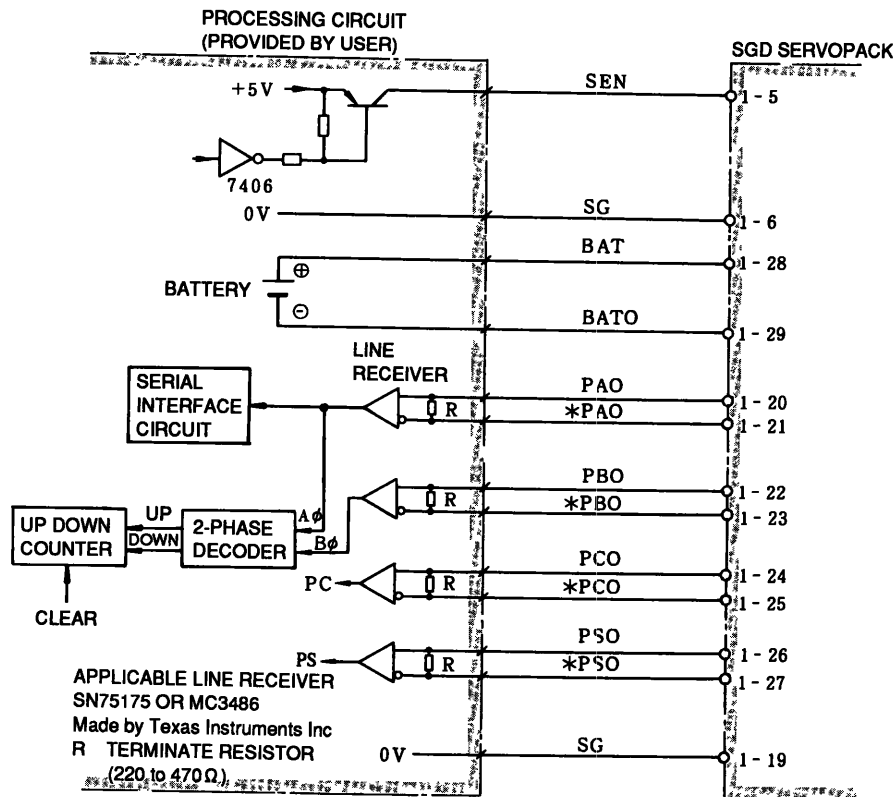

Fig 6 11 Example of Output Processing Circuit

6.4.3 Absolute Data Receive

Process absolute data in the following sequence

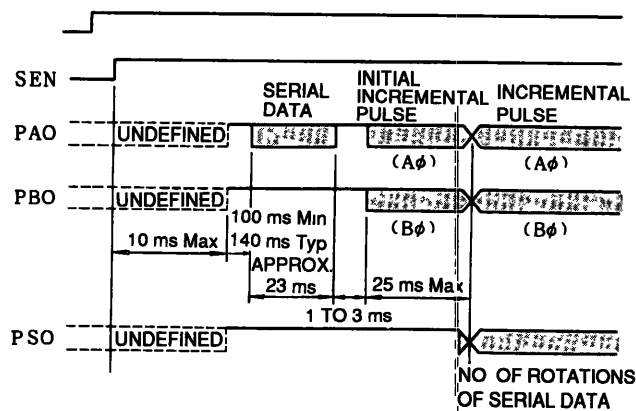

Fig 6 12 Receive Processing of Absolute Data

- ① Make the SEN signal high-level
- ② After 100 ms, set serial data reception/waiting status Clear the up/down counter to count incremental pulses
- ③ Receive serial data of 8 bytes
- ④ Normal incremental operation status is entered in approx 50 ms after the last serial data are received

6.4.4 Serial Data Specification for 12-bit Absolute Encoder Phase-A (PAO)

Table 6 1 Serial Data Specification for Phase-A

Transmission Mode	Asynchronous (ASYNC)
Baud Rate	9600 baud
Start Bit	1 bit
Stop Bit	1 bit
Parity	Even
Character Code	ASCII 7 bits
Data Format	8 characters , (P/A), (+/-), (0 to 9) × 5 digits (CR)

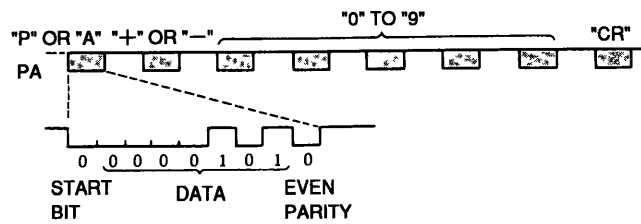

Fig 6 13 Serial Data for Phase-A

During normal operation, serial data of the number of cumulative rotations (5 digits) from the reference point (set at setup time) are output in the format shown in Table 6 1

Zero rotation is displayed by either $P + 00000 (CR)$ or $P - 00000 (CR)$

Number of cumulative rotations is counted from 0 through ± 99999 , then rotation register rolls over to ± 00000

6.4.5 Serial Data Specification for Phase-S (PSO) No. of Rotations

Table 6 2 Serial Data Specification for Phase-S

Transmission Mode	Asynchronous (ASYNC)
Baud Rate	9600 baud
Start Bit	1 bit
Stop Bit	1 bit
Parity	Even
Character Code	ASCII 7 bits
Data Format	13 characters , (P/A), (+/-), (0 to 9) × 5 digits, (0 to 9) × 4 digits (CR)

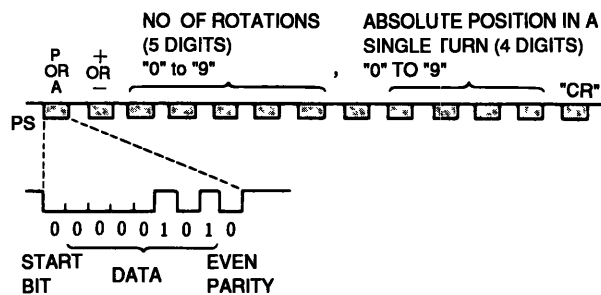

Fig 6 14 Serial Data for Phase-S

During normal operation, serial data of the number of cumulative rotations (5 digits) and the absolute position in a single turn (4 digits) are output in the format shown in Table 6.2

The send period is about 40 ms. The absolute position data increase when the motor turns counterclockwise when viewed from the drive end.

6.4.6 Incremental Pulse

Initial incremental pulse giving absolute data and normal incremental pulse are output through the frequency divider. The frequency divider is set by Cn-0A.

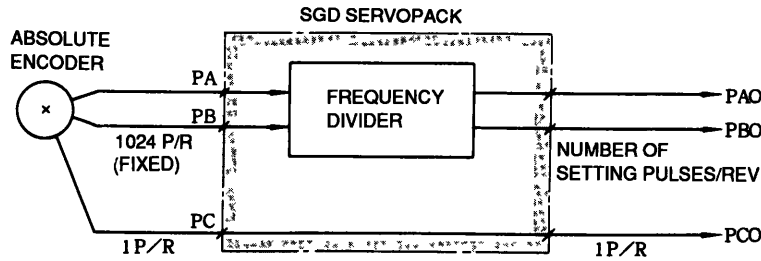
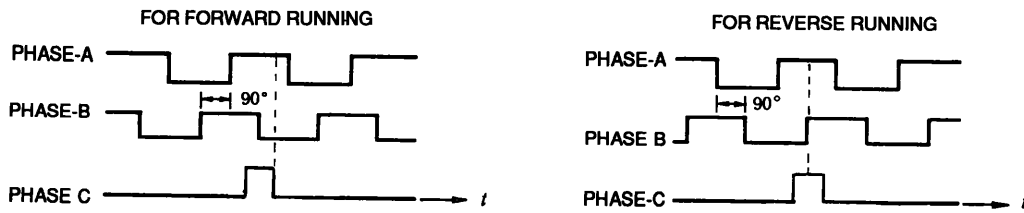

Fig 6 15 Incremental Pulse

Output Phase



Note For details of frequency dividing, refer to Par 7 (8), "PG Division Ratio Setting"

Fig 6 16 Forward/Reverse Output Phase

PCO (reference pulse) synchronizes with PAO, but the pulse width becomes narrow because PCO is not divided. If the dividing ratio is not $1/2n$, accurate 90-degree phase difference is not made and the pulses are output as shown in Fig 6 17

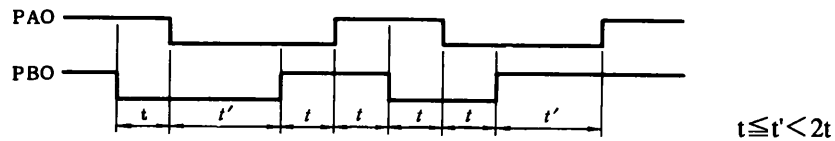

(The phase difference between t and t' is equal within one revolution, thus the minimum position error results.)

Fig 6 17 Frequency Dividing Ratio and Output Phase Difference

6.4.7 SEN Signal

- (1) When the SEN signal level is changed from low to high, +5 V power is supplied to the absolute encoder and serial data and initial incremental pulses are sent, then normal operation is started
If the SEN signal level is changed from high to low when the motor is not energized, +5 V power is not supplied to the absolute encoder
- (2) Do not change the SEN signal level from low to high for three seconds after power is turned ON. The PAO, PBO undefined time before serial data are sent is prolonged
- (3) Even if servo ON signal is entered when the SEN signal is low, the motor cannot be energized (Base block is set)
- (4) Even if servo ON signal is entered, the motor is not energized until the SEN signal is input and the encoder starts normal operation, that is, sending of serial data and initial incremental pulse is complete
- (5) When the motor is energized, the dropped SEN signal is disregarded as follows

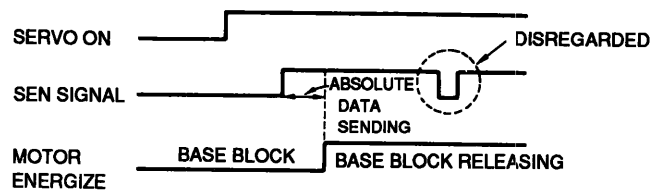

(6) Electrical Specifications

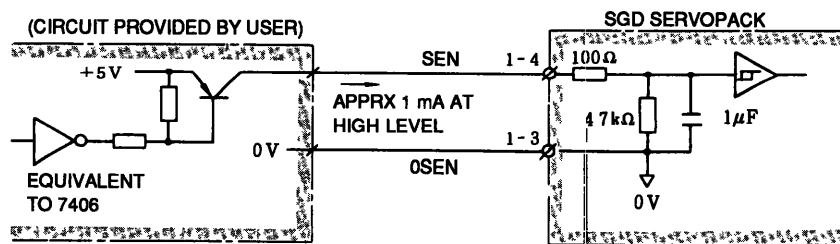

Transistor type PNP is recommended
 Signal level (High-level 4 V min
 Low-level 0.7 V Max)

Fig 6 18 Electrical Specifications of SEN Signal

6.4.8 Battery

Be sure to use battery to store position information if absolute encoder power should fail
The following battery is recommended

- Lithium battery* type ER6VC, 3.6 V 2000 mA \times 1

For battery replacement method, see Par 13.3

* Made by TOSHIBA CORP

NOTE

- Securely connect the battery so as to prevent an environmental change or a change with the passage of time from causing contact failure
- Battery voltage is not monitored in the SERVOPACK. Prevent the voltage from falling below 2.8 V. If necessary in the system, provide a low battery voltage detection circuit or monitor.
- Refer to Par 13.3 for precautions for battery replacement method

6.4.9 Setup Method for 12-bit Absolute Encoder

To clear the cumulative rotation number to zero to set up the motor, or when the absolute encoder has been left disconnected from a battery for more than two days, the encoder needs to be setup by the following procedure (Under the above conditions, capacitors in the encoder may be charged insufficiently so that the internal circuits may malfunction)

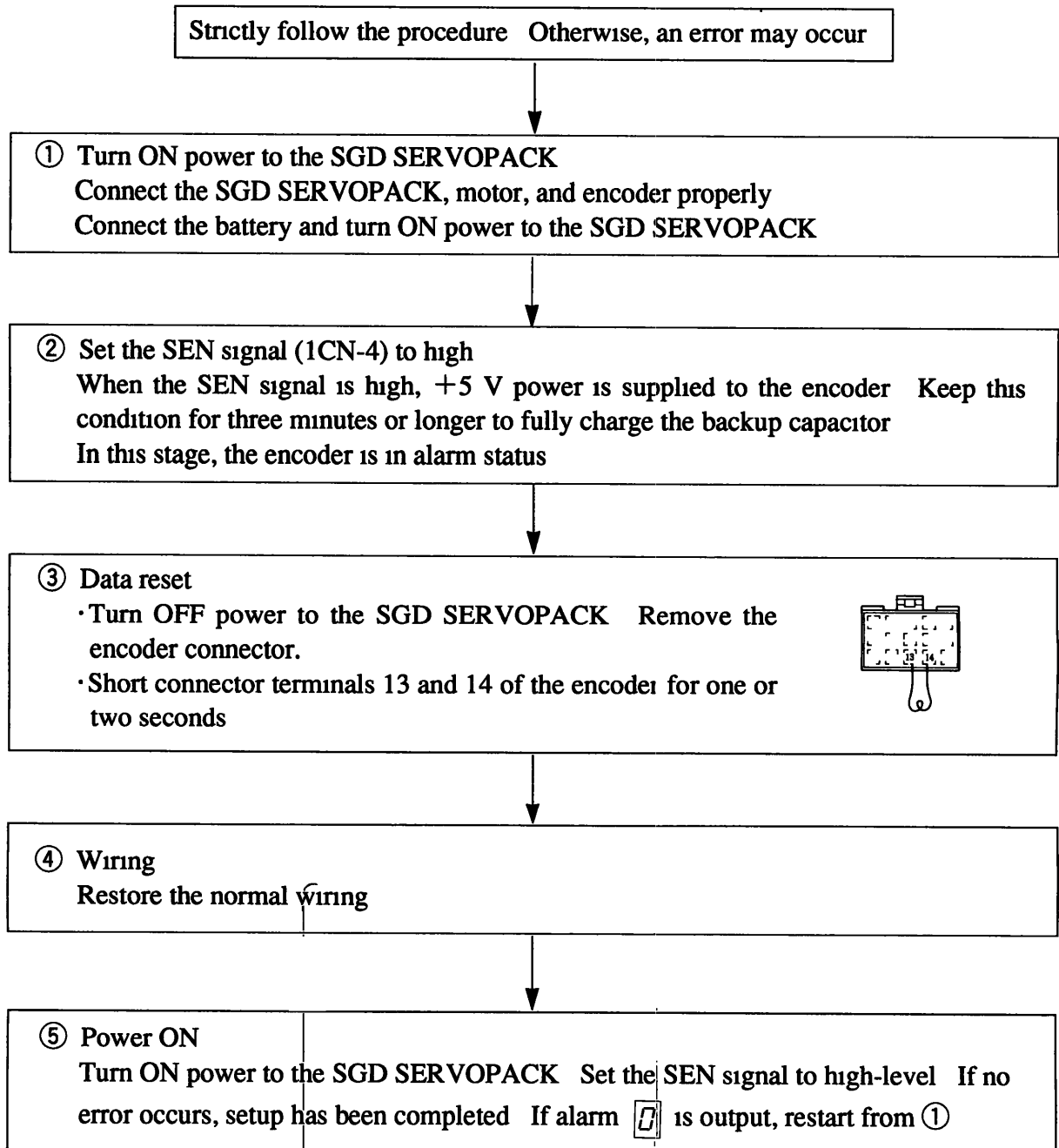

6.4.10 Alarm Output of the 12-bit Absolute Encoder

Table 6 3 lists error detection functions of the 12-bit absolute encoder

If an error occurs in the encoder while the SGD SERVOPACK is operating, the SGD SERVOPACK displays

		A	8	0
--	--	---	---	---

 on the digital operator

• Set the SEN signal (1CN-5) to low (or, turn OFF the 5 V power to the encoder) in this stage

The SGD SERVOPACK outputs SGD SERVOPACK alarm code ALM80

CR

 from the PAO output terminals (1CN-20, -21)

• Turn the SEN signal to high again (or, turn ON the 5 V power to the encoder) The encoder

outputs phase-A serial data ALARMO *

CR

 and phase-S serial data ALARMO*,

*

CR

 to the SGD SERVOPACK The SGD SERVOPACK in turn outputs phase-A

and -S serial data from the PAO and PSO output terminals When the digital operator is connected, the SGD SERVOPACK determines the type of error from the above data

and changes the display of digital operator to

		A	8	*
--	--	---	---	---

• Turn the SEN signal to low again (or, turn OFF the 5 V power to the encoder) The SGD SERVOPACK outputs the SGD SERVOPACK alarm code after judgment, ALM8

*

CR

, from the PAO output terminal

• If the SGD SERVOPACK miscounts PG pulses and the number of pulses per rotation

is an odd sum, the SGD SERVOPACK displays

		A	8	0
--	--	---	---	---

 on the digital operator but phase-A and -S serial data are not output since the encoder is functioning normally (For details of the serial data, see Table 6 4)

Table 6 3 Alarm Output

Name	Contents
Backup Alarm	Backup voltage drop is detected (This check ensures data reliability of the number of cumulative rotations)
Battery Alarm	Battery voltage drop is detected (This checks for battery replacement timing or break in wire)
Checksum Error	Memory data check resulted in an error
Overspeed	Rotation speed is 400 r/min or higher when 5 V power is turned ON
Absolute Error	Sensor check resulted in an error (indicating an internal error in the encoder)

Table 6 4 Encoder Alarm Output

Status	Input	Display	Output																											
	SEN Signal	Digital Operator Display	Phase-A Output (PAO)	Phase-S Output (PSO)																										
Normal Operation	High	<table border="1"> <tr><td> </td><td> </td><td>r</td><td>u</td><td>n</td></tr> </table> (SV ON)			r	u	n		P+ <table border="1"><tr><td> </td><td> </td><td> </td><td> </td><td> </td><td> </td><td> </td><td> </td></tr></table> , <table border="1"><tr><td> </td><td> </td><td> </td><td> </td></tr></table> CR																					
				r	u	n																								
or <table border="1"> <tr><td> </td><td> </td><td> </td><td>b</td><td>b</td></tr> </table> (SV OFF)				b	b	H+ <table border="1"><tr><td> </td><td> </td><td> </td><td> </td><td> </td><td> </td><td> </td><td> </td></tr></table> , <table border="1"><tr><td> </td><td> </td><td> </td><td> </td></tr></table> CR Also (d), ('), (D) and (B) are available																								
			b	b																										
Error Occurrence	Low (Encoder power OFF)	<table border="1"> <tr><td> </td><td> </td><td>A</td><td>8</td><td>0</td></tr> </table>			A	8	0		ALM80 CR (SGD SERVOPACK Alarm Code)	Not Specified																				
				A	8	0																								
		<table border="1"> <tr><td> </td><td> </td><td>A</td><td>8</td><td>*</td></tr> </table>			A	8	*		ALARMO* CR (Phase-A Serial Data)	ALARMO* **** CR																				
				A	8	*																								
<table border="1"> <tr><td> </td><td> </td><td> </td><td> </td><td>b</td><td>b</td></tr> </table>					b	b	ALM8* CR (SGD SERVOPACK Alarm Code)	Not Specified																						
				b	b																									
<table border="1"> <tr><td> </td><td> </td><td> </td><td> </td><td>r</td><td>u</td><td>n</td></tr> </table> (SV ON)					r	u	n		A+ <table border="1"><tr><td> </td><td> </td><td> </td><td> </td><td> </td><td> </td><td> </td><td> </td></tr></table> CR (P)									A+ <table border="1"><tr><td> </td><td> </td><td> </td><td> </td><td> </td><td> </td><td> </td><td> </td></tr></table> , <table border="1"><tr><td> </td><td> </td><td> </td><td> </td></tr></table> CR												
				r	u	n																								
Low (Encoder power OFF)	<table border="1"> <tr><td> </td><td> </td><td> </td><td> </td><td>r</td><td>u</td><td>n</td></tr> </table> (SV ON)					r	u	n		P+ <table border="1"><tr><td> </td><td> </td><td> </td><td> </td><td> </td><td> </td><td> </td><td> </td></tr></table> , <table border="1"><tr><td> </td><td> </td><td> </td><td> </td></tr></table> CR																				
				r	u	n																								

(Perform an alarm reset For the reset method, refer to Par 8 3)

When no error is detected	Low→High (Encoder Power ON)	<table border="1"> <tr><td> </td><td> </td><td> </td><td> </td><td>b</td><td>b</td></tr> </table>					b	b	<table border="1"> <tr><td> </td><td> </td><td> </td><td> </td><td> </td><td> </td><td> </td><td> </td></tr> </table> CR (P)									A+ <table border="1"><tr><td> </td><td> </td><td> </td><td> </td><td> </td><td> </td><td> </td><td> </td></tr></table> , <table border="1"><tr><td> </td><td> </td><td> </td><td> </td></tr></table> CR												
						b	b																							
<table border="1"> <tr><td> </td><td> </td><td> </td><td> </td><td>r</td><td>u</td><td>n</td></tr> </table> (SV ON)					r	u	n		P+ <table border="1"><tr><td> </td><td> </td><td> </td><td> </td><td> </td><td> </td><td> </td><td> </td></tr></table> , <table border="1"><tr><td> </td><td> </td><td> </td><td> </td></tr></table> CR																					
				r	u	n																								

Note

"

--	--	--	--

" shows optional numbers

"****" shows optional characters and numbers (It depends on the type of alarm code For details, see Table 6 5)

Table 6 5 Output in accordance with Encoder Alarm

Alarm	Display	Phase-A Output (PAO)		Phase-S Output (PSO)								
	Digital Operator Display	(Phase-A Serial Data)	(SGD-SERVOPACK Alarm Code)	(Phase-S Serial Data)								
Backup Alarm	<table border="1"><tr><td></td><td></td><td>A</td><td>8</td><td>1</td></tr></table>			A	8	1	ALARMOA <table border="1"><tr><td>CR</td></tr></table>	CR	ALM 81 <table border="1"><tr><td>CR</td></tr></table>	CR	ALARMOA, BACK <table border="1"><tr><td>CR</td></tr></table>	CR
		A	8	1								
CR												
CR												
CR												
Battery Alarm	<table border="1"><tr><td></td><td></td><td>A</td><td>8</td><td>3</td></tr></table>			A	8	3	ALARMOD <table border="1"><tr><td>CR</td></tr></table>	CR	ALM 83 <table border="1"><tr><td>CR</td></tr></table>	CR	ALARMOD, BATT <table border="1"><tr><td>CR</td></tr></table>	CR
		A	8	3								
CR												
CR												
CR												
Checksum Error	<table border="1"><tr><td></td><td></td><td>A</td><td>8</td><td>2</td></tr></table>			A	8	2	ALARMOB <table border="1"><tr><td>CR</td></tr></table>	CR	ALM 82 <table border="1"><tr><td>CR</td></tr></table>	CR	ALARMOB, CHEC <table border="1"><tr><td>CR</td></tr></table>	CR
		A	8	2								
CR												
CR												
CR												
Overspeed	<table border="1"><tr><td></td><td></td><td>A</td><td>8</td><td>5</td></tr></table>			A	8	5	ALARMOP <table border="1"><tr><td>CR</td></tr></table>	CR	ALM 85 <table border="1"><tr><td>CR</td></tr></table>	CR	ALARMOP, OVER <table border="1"><tr><td>CR</td></tr></table>	CR
		A	8	5								
CR												
CR												
CR												
Absolute Error	<table border="1"><tr><td></td><td></td><td>A</td><td>8</td><td>4</td></tr></table>			A	8	4	ALARMOH <table border="1"><tr><td>CR</td></tr></table>	CR	ALM 84 <table border="1"><tr><td>CR</td></tr></table>	CR	ALARMOH, ABSO <table border="1"><tr><td>CR</td></tr></table>	CR
		A	8	4								
CR												
CR												
CR												
Backup Alarm + Battery Alarm	<table border="1"><tr><td></td><td></td><td>A</td><td>8</td><td>1</td></tr></table>			A	8	1	ALARMOE <table border="1"><tr><td>CR</td></tr></table>	CR	ALM 81 <table border="1"><tr><td>CR</td></tr></table>	CR	ALARMOE, BACK <table border="1"><tr><td>CR</td></tr></table> (or BATT)	CR
		A	8	1								
CR												
CR												
CR												

Notes

- 1 Digital operator display and SGD SERVOPACK alarm codes are also output for alarms that occurred within the SGD SERVOPACK other than the above encoder alarms. For details of the SGD SERVOPACK alarm codes, refer to Par 6 5, "Protective Functions "
- 2 The digital operator is SGD SERVOPACK peripheral equipment. For details, refer to Par 8, "DIGITAL OPERATOR "

Table 6 6 Alarm Displays

Digital Operator (Traceback Data)	Alarm Code Serial Output	ALM Output	Detection
<i>RD0</i>	ALM 00 CR	×*	Absolute Encoder Data Error
<i>RD2</i>	ALM 02 CR	×	Parameter Breakdown
<i>RD4</i>	ALM 04 CR	×	Parameter Setting Error
<i>R10</i>	ALM 10 CR	×	Overcurrent
<i>RY0</i>	ALM 40 CR	×	Overvoltage
<i>RS1</i>	ALM 51 CR	×	Feedback Overspeed (Detected at 110% of max speed)
<i>RS2</i>	ALM 52 CR	×	Overspeed Reference Input (Detected at 110% of max speed)
<i>R71</i>	ALM 71 CR	×	Overload (Momentary overload)
<i>R72</i>	ALM 72 CR	×	Overload (Continuous overload)
<i>RD0</i>	ALM 80 CR	×	Encoder Error
<i>RD1</i>	ALM 81 CR	×	Encoder Backup Alarm †
<i>RD2</i>	ALM 82 CR	×	Encoder Checksum Error †
<i>RD3</i>	ALM 83 CR	×	Encoder Battery Alarm †
<i>RD4</i>	ALM 84 CR	×	Encoder Absolute Error
<i>RD5</i>	ALM 85 CR	×	Encoder Overspeed †
<i>Rb1</i>	ALM b1 CR	×	Reference Input Read Error
<i>RC1</i>	ALM c1 CR	×	Overrun
<i>RC3</i>	ALM c3 CR	×	PA-, PB-phase Disconnection of PG Signal Line
<i>RC4</i>	ALM c4 CR	×	PC Disconnection of PG Signal Line
<i>RF3</i>	ALM F3 CR	×	Momentary Power Loss Alarm (Detected when power is turned ON again during power holding time)

* ○ Output transistor ON
 × Output transistor OFF

† Detected only when 12-bit absolute encoder is used

6.4.11 Alarm Code Serial Output

The alarm contents are output as serial data from PAO output (1CN-20, 21 pins)

(1) Serial data receiving

Use a sequence as shown in Fig 6 19 to process alarm data

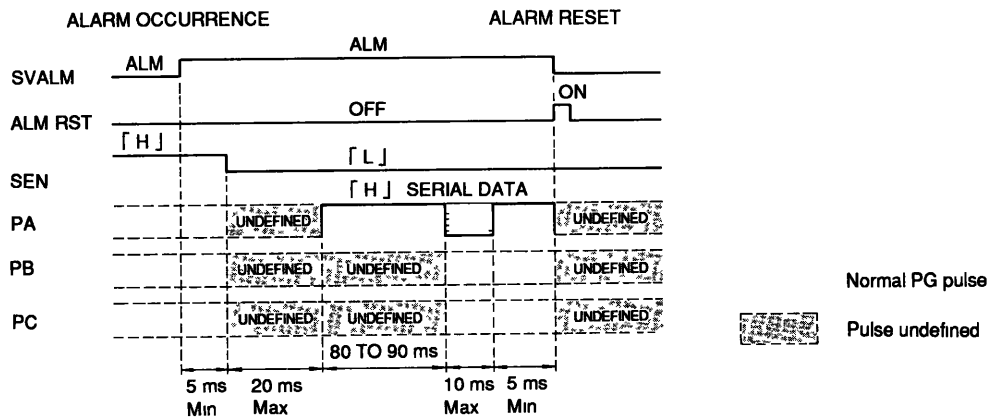

Fig 6 19 Alarm Data Receiving Process

- ① Make the SEN signal low level at servo alarm occurrence (in alarm status)
- ② After 20 ms, set serial data reception-waiting-state
- ③ Receive serial data of 7 bytes
- ④ Alarm releasing process is enabled approx 5 ms after the last serial data are received

Note When any SEN signals other than in servo alarm status are changed from low level to high level, absolute data are transferred

(2) Alarm serial data specifications

Data Transmission Method	Asynchronous (ASYNC)
Baud Rate	9600 bauds
Start Bit	1 bit
Stop Bit	1 bit
Parity	Even
Character Code	ASCII 7 bits
Data Format	7 characters (A) (L) (M) (alarm code) () (CR)

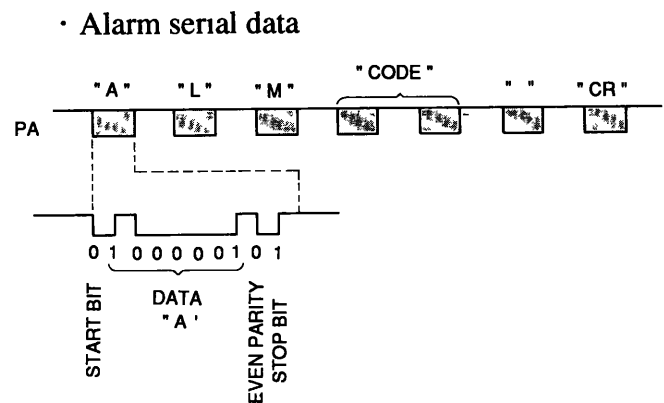

Fig 6 20 Serial Data

• 7 bytes of serial data (7 characters) are sent

(A), (L), (M), (alarm code), () and (CR) are available for the format

(CR) is the code of carriage return

Refer to Table 6 6 for alarm codes

6.5 PROTECTIVE FUNCTIONS

SGD SERVOPACK provides functions to protect the drive and motor from malfunctions

6.5.1 Dynamic Brake Function

SGD SERVOPACK incorporates a dynamic brake for emergency stop. This brake operates when ·

- Alarm (fault detection) occurs
- Servo ON input is opened
- Power supply is turned OFF
- Overtravel (P/N-OT) occurs.

Coasting to a stop can also be selected by user constant setting

6.5.2 Alarm Detection Functions

Table 6 7 lists alarm detection functions of the SGD SERVOPACK. Type of alarm is identified by a combination of three alarm code outputs

Table 6 7 Alarm Detection Function

○ Output transistor ON
× Output transistor OFF

Digital Operator JUSP-OP02A-1 Type JUSP-OP03A Type	Output Form				Alarm Detection Function	Detection Contents
	Alarm Output Code			SV ALM Output		
	AL01	AL02	AL03			
R0*	×	×	×	×	Parameter error	An absolute error or parameter error is detected
R10	○	×	×	×	Overcurrent	<ul style="list-style-type: none"> An overcurrent for the main circuit is detected An overheat for the SERVOPACK heat sink is detected
R40	×	×	○	×	Overvoltage	The main circuit DC voltage exceeds about 420 V
R5*	○	×	○	×	Overspeed	<ul style="list-style-type: none"> The motor speed exceeds the maximum allowable rotation speed Speed reference voltage exceeding the max rotation speed is input
R7*	○	○	○	×	Overload	An overload to the motor and the SGD SERVOPACK is detected
Rb1	×	×	×	×	Reference input read error	Trouble with the circuit on the SGD SERVOPACK board is detected
Rc*	○	×	○	×	<ul style="list-style-type: none"> Phase Detection Error Overrun Disconnection of PG signal line 	<ul style="list-style-type: none"> Overrun resulting from connection error of the motor or PG signals Disconnection is detected in PG signal cables
R8*	×	×	×	×	Encoder alarm	Absolute encoder alarm
Rf3	×	○	×	×	Momentary power loss	Momentary power failure (less than holding time) is detected
CPF00 CPF01	(not specified)				Digital operator (transmission error)	Transmission error between digital operator and SGD SERVOPACK
R99	×	×	×	○	This is not an alarm	

* A numeral appears in this position identifying the type of the alarm (For details, see Tables 8A 6 and 8B 6)

6.5.3 Servo Alarm Output (ALM, ALM-SG)

If any of the alarm detection functions listed in Par 6 5 2 is activated, the power drive circuit in the SGD SERVOPACK is turned OFF and an alarm display is output

- When no digital operator is provided The red LED on the SGD SERVOPACK lights
- When a digital operator is provided Alarm contents are displayed on the digital operator (See Table 6 3) An alarm code is also output to external equipment through open collector output circuits ALO1 to ALO3 For the alarm codes, see Table 6 7

6.5.4 Protective Circuit Operation

An alarm signal indicates some trouble Check the cause and fix the problem and restart the operation

Procedure for troubleshooting and corrective action

Using the error traceback mode function of the digital operator (JUSP-OP02A-1 or -OP03A), check history of errors and take action according to Table 14 2

6.5.5 Resetting Servo Alarm

To reset a servo alarm, input the alarm reset signal or turn OFF power

6.6 DISPLAY

(1) When no Digital Operator is Provided

Displays on the front panel of the SGD SERVOPACK

- Power ON . Green LED "ON"
- Alarm occurred Red LED "ON"

(2) When a Digital Operator is Provided

Status of the SGD SERVOPACK is displayed (For details, refer to Par 8, "DIGITAL OPERATOR (JUSP-OP02A-1, -OP03A) "

6.7 PRECAUTIONS FOR APPLICATION

6.7.1 Overhanging Loads

The motor is rotated by the load , it is impossible to apply brake (regenerative brake) against this rotation and achieve continuous running

Example Driving a motor to lower objects (without counterweight)

Since SGD SERVOPACK has short time regenerative brake capability (corresponding to the motor stopping time), for application to a overhanging loads, contact your YASKAWA representative

6.7.2 Load Inertia J_L

For the allowable load inertia J_L converted to the motor shaft, refer to the following figs (200 VAC, with incremental encoder)

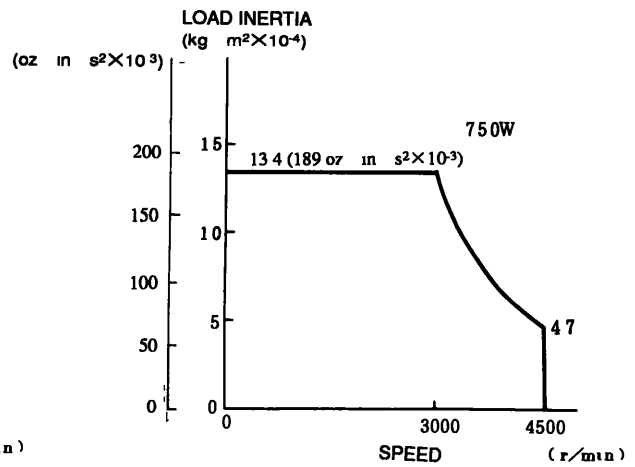
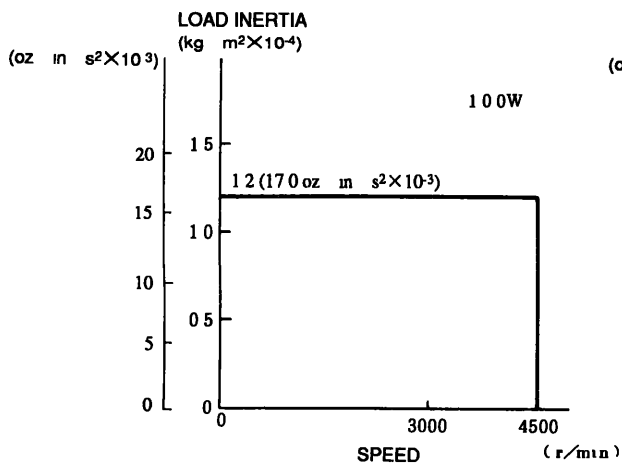
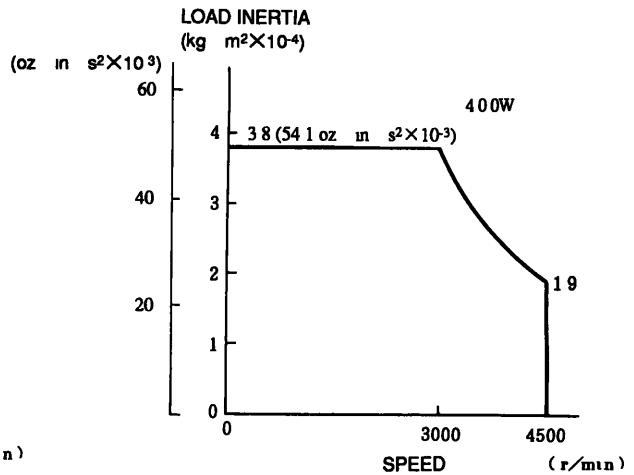
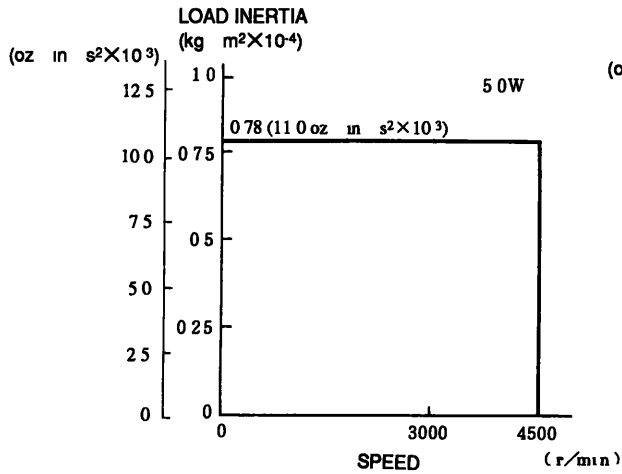
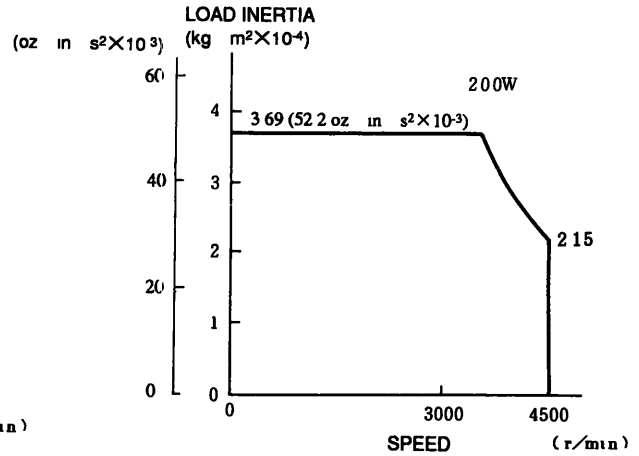
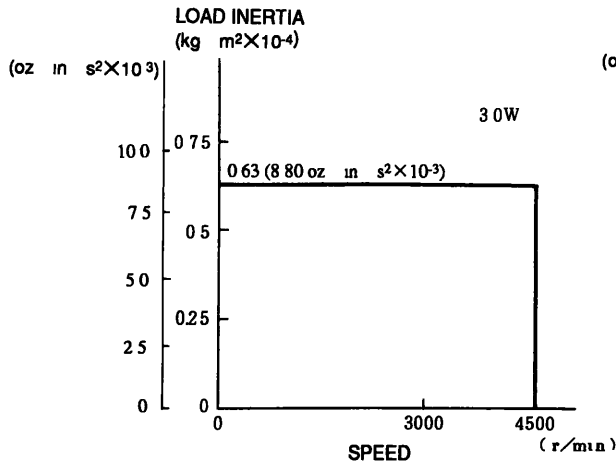

If the allowable inertia is exceeded, an overvoltage alarm may be occurred during deceleration. If this occurs, take one or more of the following actions:

- Reduce the current limit
- Slow down the deceleration curve
- Decrease the maximum speed
- Provide a regenerative unit

For details, contact your YASKAWA representative

6.7.3 Regenerative Unit (Peripheral Device for SGD SERVOPACK)

(1) Rating and Specifications

Table 6.8 Specifications of Regenerative Unit

Type	JUSP-RG08	Remarks
Applicable SGD SERVOPACK	SGD-..	
Regenerative Operation Voltage	380 VDC	
Regenerative Current	8 ADC	Regenerative resistance value 50Ω, 60 W
Alarm Detection Function	Regenerative resistance disconnection, regenerative TR malfunction, overvoltage	
Alarm Output	1b contact (contact "open" at protective function operation)	200V operation is available
Size in mm (in inches)	55 W × 160 H × 130 D (2 17 W × 6 30 H × 5 12 D)	

(2) Recommended Connection

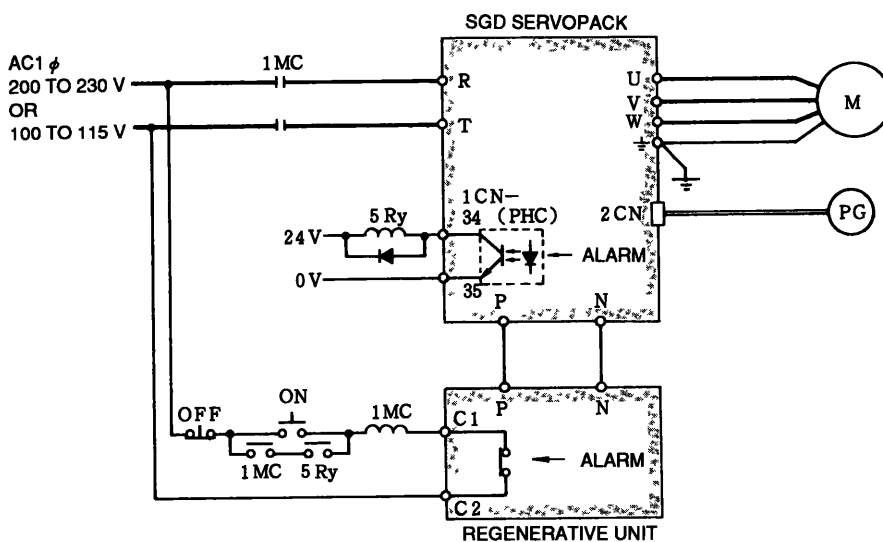

Fig 6.21 Connecting of Regenerative Unit

(3) Notes on Applications

- The regenerative unit has three alarm detection functions (regenerative-resistance-disconnection detection, regenerative-TR-malfunction detection and overvoltage detection)
- If any of these trouble detection function is activated, the internal alarm relay is tripped, and connection between output terminals (C1) and (C2) on the regenerative unit becomes open
- Make a sequence so that power supply (R-T) to the SGD SERVOPACK is turned OFF whenever the alarm relay is activated
- It takes two or three seconds after the alarm relay is activated until it recovers to normal status (The relay recovers when the main capacitor in the SGD SERVOPACK has been fully discharged)

6.7.4 High Voltage Line

If the supply voltage is 400/440 V, the voltage must be dropped to 200 V or 100 V using a power transformer. Table 6.9 shows the transformer selection. Connection should be made so that the power is supplied and cut through the primary side of the transformer.

6.8 PRECAUTIONS OF OPERATION

6.8.1 Noise Control

SGD SERVOPACK uses high-speed switching elements in the main circuit. When these high-speed switching elements are switched, the effect of $\frac{di}{dt}$ or $\frac{dv}{dt}$ (switching noise) may sometimes occur depending on the wiring or grounding method.

SGD SERVOPACK incorporates a CPU. This requires wiring and provision to prevent noise interference. To reduce switching noise as much as possible, the recommended method of wiring and grounding is shown in Fig. 6.22.

(1) Grounding Method

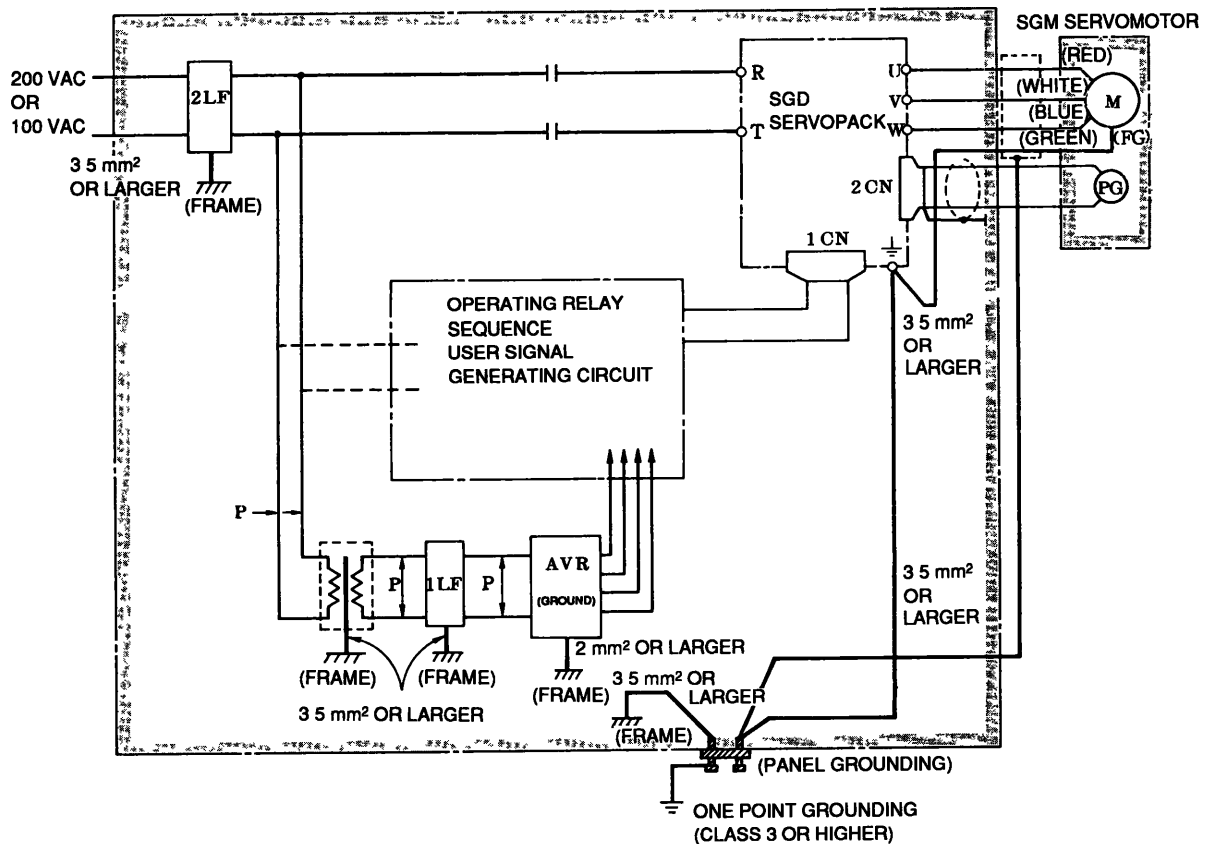

 Twisted pair wires

Notes

- 1 Use wires of 3.5 mm² or larger for grounding to the case (preferably flat-woven copper wire)
- 2 Connect line filters observing the precautions as shown in (2), "Noise filter installation"

Fig. 6.22 Grounding Method

Motor frame grounding

When the motor is at the machine side and grounded through the frame, $Cf \frac{dv}{dt}$ current flows from the PWM power through the stress capacitance of the motor. To prevent this effect of current, motor ground terminal FG (motor frame) should be connected to terminal \oplus of SGD SERVOPACK (Terminal \ominus of SGD SERVOPACK should be directly grounded)

·SGD SERVOPACK SG 0 V

Noise may remain in the input signal line, so make sure to ground SG 0 V. When motor wiring is contained in metal conduits, the conduits and boxes must be grounded. The above grounding uses one-point grounding.



(2) Noise Filter Installation

When noise filters are installed to prevent noise from the power line, the block type must be used. The recommended noise filters are shown in Table 6.9. The power supply to peripherals also needs noise filters.

NOTE

If the noise filter connection is wrong, the effect decreases greatly. Observing the precautions, carefully connect them as shown in Figs 6.23 to 6.26.

Table 6.9 Recommended Noise Filter

Class	SGD SERVOPACK Type		Applicable Noise Filter	Recommended Noise Filter*	
				Type	Specifications
200 VAC	30 W (0.04 HP)	SGD-A3AS	 Good	LF-205A	Single-phase 200 VAC class, 5A
	50 W (0.07 HP)	SGD-A5AS			
	100 W (0.13 HP)	SGD-01AS			
	200 W (0.27 HP)	SGD-02AS		LF-210	Single-phase 200 VAC class, 10 A
	400 W (0.53 HP)	SGD-04AS		LF-220	Single-phase 200 VAC class, 20 A
	750 W (1.01 HP)	SGD-08AS			
100 VAC	30 W (0.04 HP)	SGD-A3BS	 Poor	LF-205A	Single-phase 200 VAC class, 5 A
	50 W (0.07 HP)	SGD-A5BS			
	100 W (0.13 HP)	SGD-01BS		LF-210	Single-phase 200 VAC class, 10 A
	200 W (0.27 HP)	SGD-02BS			

* Made by Tokin Corp

6.8.1 Noise Control (Cont'd)

- (a) Separate the input and output leads
Do not bundle or run them in the same duct

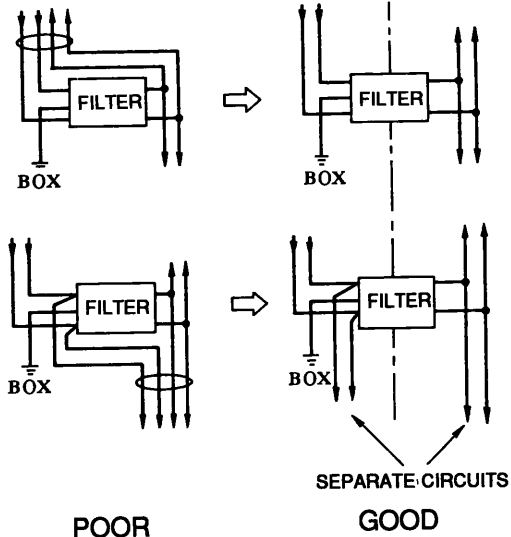

Fig 6 23

- (b) Do not bundle the ground lead with the filter output line or other signal lines or run them in the same duct

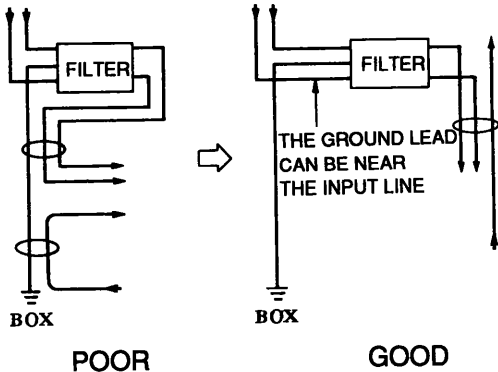

Fig 6 24

- (c) Connect the ground lead singly to the box or the ground panel

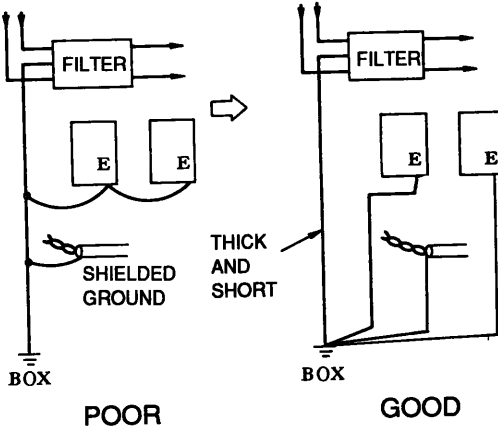

Fig 6 25

- (d) If the control panel contains the filter, connect the filter ground and the equipment ground to the base of the control unit

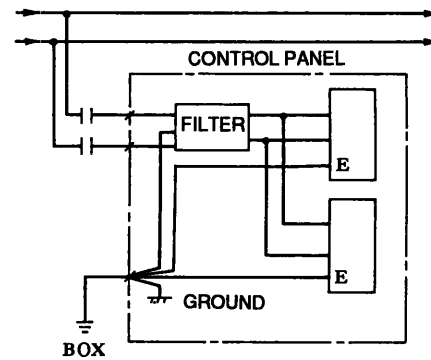

Fig 6 26

6.8.2 Power Line Protection

SGD SERVOPACK is operated through the commercial power line (200 V or 100 V). To prevent power line accidents due to grounding error, contact error, or to protect the system from a fire, circuit breakers (MCCB) or fuses must be installed according to the number of SGD SERVOPACKS used (Table 6 10).

A fast blow fuse cannot be used, because of the in-rush current.

Table 6 10 Power Supply Capacity and MCCB or Fuse Capacity

Class	SGD SERVOPACK Type	Power Capacity Per SGD SERVOPACK * kVA	Current Capacity per MCCB or Fuse † A
200 V AC	SGD-A3AS	0.25	5
	SGD-A5AS	0.3	
	SGD-01AS	0.5	
	SGD-02AS	0.75	9
	SGD-04AS	1.2	
	SGD-08AS	2.2	
100 V AC	SGD-A3BS	0.2	5
	SGD-A5BS	0.3	
	SGD-01BS	0.5	8
	SGD-02BS	0.75	

* Values at rated load

† Overload characteristics (25°C) 200%/2s or more, 700%/0.01s or more

6.9 APPLICATION

6.9.1 Connection for Reverse Motor Running

If the machine construction requires that the normal forward rotation reference is used for reverse motor running and the normal reverse rotation reference for forward running, set bit 0 of user constant Cn-02 to 1, or short circuit across terminals (2CN-1) and (2CN-7) on the PG connector (2CN)

In this case, other change of motor and PG connection is not required

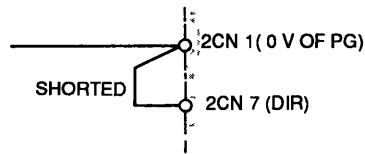

Fig 6 27

As for the divider outputs from the SGD SERVOPACK, phase-B precedes phase-A by 90 degrees when forward rotation reference is input

6.9.2 Holding Brake Interlock Signal

A brake signal can be output for interlocking motor circuit power ON/OFF status and motor rotation speed.

< Setup procedure >

The brake signal is output from 1CN-7 (10). Delay time t_B [$\times 10$ ms] from start of braking to motor power OFF can be adjusted by setting a value for user constant Cn-12

Table 6 11 Brake Timing

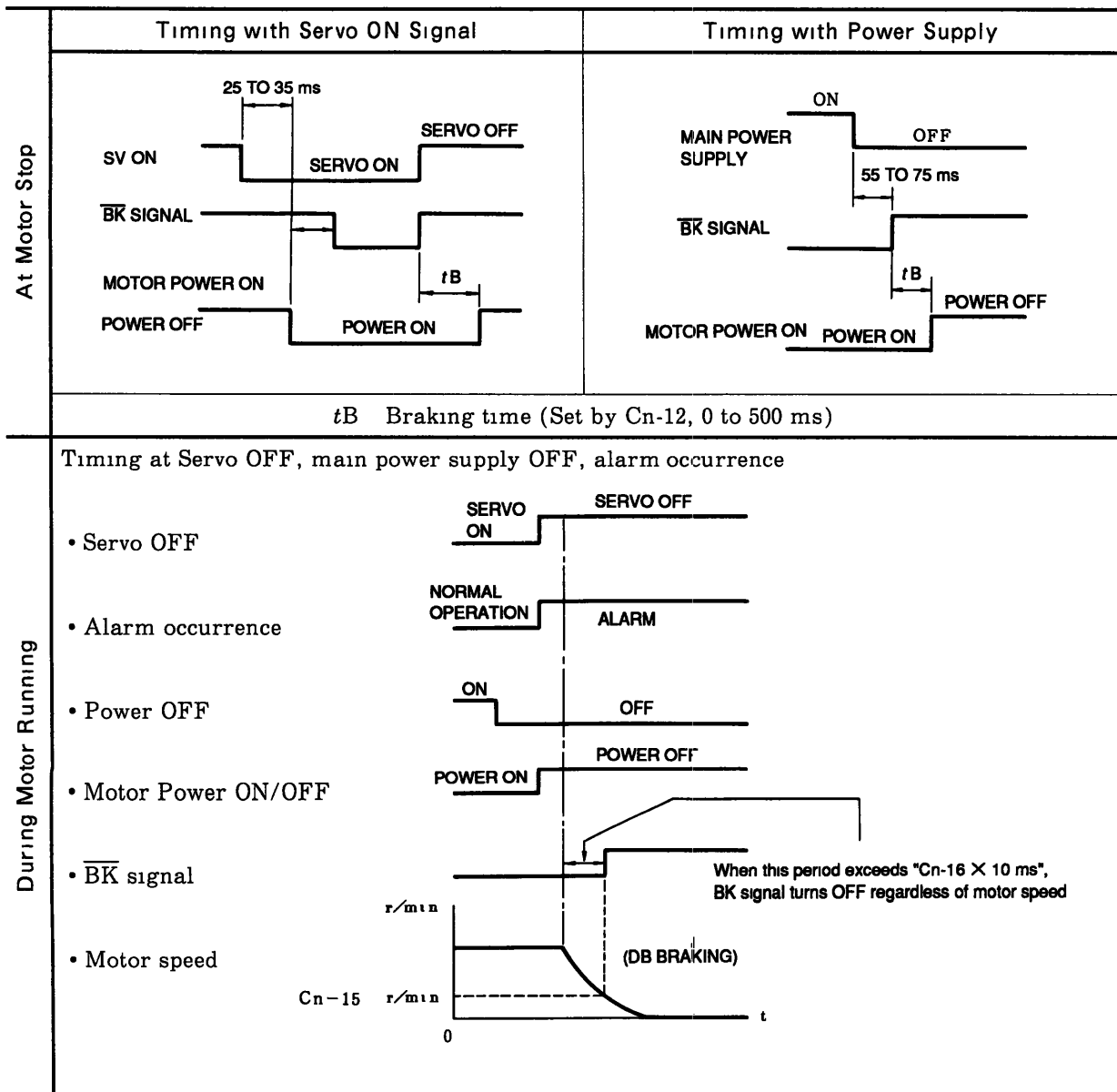

7. USER CONSTANTS

SGD SERVOPACK supports the following user constants that can be set up and modified to fit the system

Learn the meanings of these constants and use them Use the digital operator to set up and modify them (See Par 8, "DIGITAL OPERATOR (JUSP-OP02A-1, -OP03A) "

- (1) **Speed Reference Adjustment Gain Cn-03 (VREFGN)**
 - This constant is for adjusting motor speed reference Possible adjustment range is from 0 to 2162 (r/min /V)
 - Factory setting is rated speed/6 V
- (2) **Speed Loop Gain Cn-04 (LOOPHZ)**
 - This is the proportional gain for the speed controller Adjustment range is from 1 to 2000 (Hz) (when used at an equivalent inertia)
 - Factory setting is 80 (Hz)
 - When motor is rotated without load, set to 40 (Hz) or lower
- (3) **Speed Loop Integration Time Constant Cn-05 (PITIME)**
 - This is integration time for the speed controller Adjustment range is from 2 to 10,000 (ms)
 - Factory setting is 20 (ms)
- (4) **Emergency Stop Torque Cn-06 (EMGTRQ)**
 - Set up braking torque for overtravel stop (a percentage of the motor is rated torque) Setting range is from 0% to the maximum torque (100% = rated torque)
 - It is possible to decelerate the motor at the set torque value, if the overtravel inputs P/N-OT are triggered (1CN-16, -17 set bit 8 of Cn-01)
 - Factory setting is the maximum torque
- (5) **Soft Start Time Cn-07 (SFSACC), Cn-23 (SFSDEC)**
 - This constant sets time required to accelerate from 0 r/min to the maximum rotation speed to Cn-07 and to decelerate from the maximum rotation speed to 0 r/min to Cn-23 Setting range is from 0 to 10,000 (ms)
 - Factory setting is 0 (ms)
 - If positioning control is to be performed, normally set the constant to 0 (ms)
 - Both Cn-07 and Cn-23 should be setup
- (6) **Forward Running Torque Limit Cn-08 (TLMTF)**
 - This is torque limit of the motor in the forward running direction Setting range is from 0% to the maximum torque (100% = rated torque)
 - Factory setting is the maximum torque.
- (7) **Reverse Running Torque Limit Cn-09 (TLMTR)**
 - This is torque limit of the motor in the reverse running direction Setting range is from 0% to the maximum torque (100% = rated torque)
 - Factory setting is the maximum torque

(8) PG Dividing Ratio Setting Cn-0A (PGRAT)

- Number of detected (phase-A and -B) pulses per rotation sent from the PG (encoder) is converted to the pulse number according to the setting of this constant and is output to 1CN-20 to -23
- Set the number of output pulses per rotation Setting range depends on the PG
See the following table

Encoder	Number of Encoder Pulses (P/R)	Dividing Pulse Set Value
Incremental Encoder	2048	Any integer from 16 to 2048
Absolute Encoder	1024	Any integer from 16 to 1024

(9) Zero-Speed Level Cn-0B (TGONLV)

- This is motor zero-speed determination level Setting range is from 1 (r/min) to the maximum speed
- When the motor rotation speed exceeds the set value, sequence output TGON is turned ON (between 1CN-9 and -10 are "closed")
- Factory setting is 20 (r/min.)

(10) Mode Switches

- The following constants are used for setting mode switch operating points Detection points where PI control is switched to P control are set for improving transient characteristic of acceleration, deceleration and output saturation of the speed controller
Different levels can be set for three types of detection points for the mode switch

Torque reference (output from the speed controller) · Cn-0C (TRQMSW)

Speed reference Cn-0D (REFMSW)

Detection of motor acceleration · Cn-0E (ACCMSW)

- The detection points can be selected by setting bits of user constant Cn-01

(11) Zero-clamp Level Cn-0F (ZCLVL)

- This is the motor rotation speed level at which zero-clamp is performed Setting range is from 0 to the maximum speed
- During speed control with zero-clamp (set by bit A or B of Cn-01), if contact input P-CON is ON when the motor rotation speed drops to the set value or lower, speed reference is disconnected and the motor speed is reduced to zero After the motor is stopped, servo lock status is maintained

(12) Jog Speed Cn-10 (JOGSPD)

- Set up jogging speed Setting range is from 0 r/min to the maximum speed
- To start jogging, enter the operation reference from the digital operator
- Factory setting is 500 (r/min)

(13) Encoder Pulse Number Cn-11 (PULSNO)

- This is the number of pulses per rotation of the motor encoder
- Factory setting is 2048 (P/R)
- When 12-bit absolute encoder is used, set to 1024 (P/R)

(14) Delay Time from Brake Reference Output to SVOFF Operation Cn-12 (BRKTIM)

- This is delay time from the output of brake reference to the actuation of SVOFF for a motor with a brake. Setting range is from 0 ms to 500 ms, in increments of 10 ms
- Factory setting is 0 (× 10 ms)

(15) Selection of Sequence Inputs, Reference Signal Error Stop Methods, Control Modes, and Mode Switches

Use user constant Cn-01 memory switches for the above selections (For the assignment and explanation of the memory switches, see Table 7 4, "User Constant Cn-01 List.")

See sequences (a), (b) and select an error stop method fit for the system

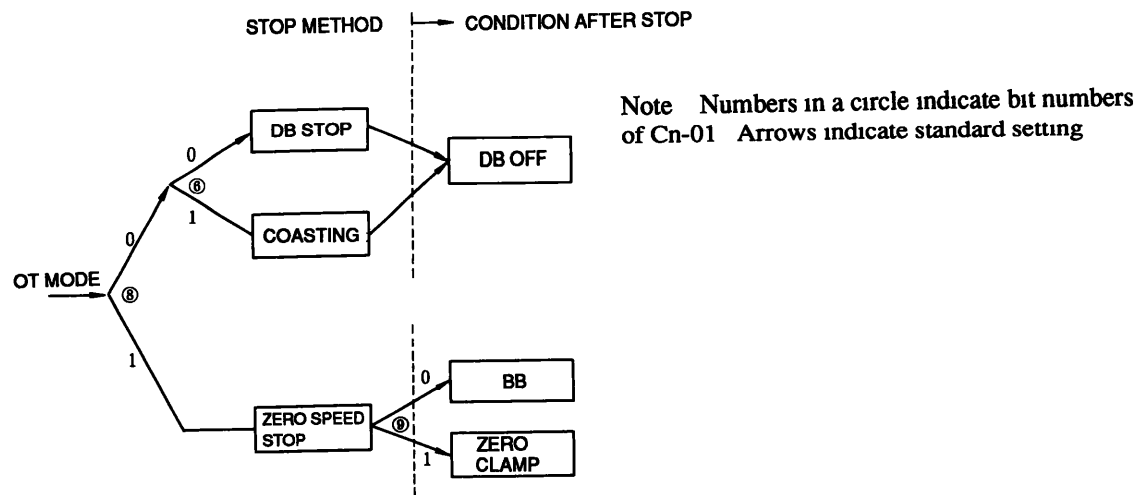

(a) Sequence on OT mode

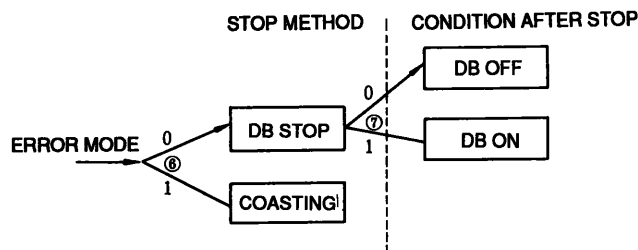

(b) Sequence on fault mode (except OT mode)

Fig 7 1 Error Stop Sequences

(16) **Forward Rotation External Current Limit Cn-18 (CLMIF)**

This is motor current limit in the forward rotation direction. This limit is effective when contact input $\overline{\text{P-CL}}$ (1CN-11) is ON. Setting range is from 0% to the maximum torque (100% = rated torque). Factory setting is the maximum torque.

(17) **Reverse Rotation External Current Limit Cn-19 (CLMIR)**

This is motor current limit in the reverse rotation direction. This limit is effective when contact input $\overline{\text{N-CL}}$ (1CN-12) is ON. Setting range is from 0% to the maximum torque (100% = rated torque). Factory setting is the maximum torque.

(18) **Contact Input Speed Control**

The following constants are used to enter a mode where speed control is performed according to contact inputs $\overline{\text{P-CL}}$ and $\overline{\text{N-CL}}$ (1CN-11, -12).

Three speeds are programmed.

Corresponding user constants are shown below.

1st speed Cn-1F (SPEED1)

2nd speed Cn-20 (SPEED2)

3rd speed Cn-21 (SPEED3)

Setting range of each constant is from 0 (r/min) to the maximum speed. Factory setting is 100 (r/min) for the first speed, 200 (r/min) for the second, and 300 (r/min) for the third.

Table 7 1 Speed Setting

Selected Speed	$\overline{\text{N-CL}}$	$\overline{\text{P-CL}}$
1st	ON	OFF
2nd	ON	ON
3rd	OFF	ON
Stop	OFF	OFF

Table 7 2 Rotation Direction Setting

Rotation Direction	$\overline{\text{P-CON}}$
Forward	OFF
Reverse	ON

(19) **Speed Coincidence Signal Output Width Cn-22 (VCMPLV)**

The speed coincidence signal is output when the absolute value of the difference between the speed reference and actual rotation speed (speed deviation) is not greater than the set value. For example, if set value is 100 r/min and commanded speed is 2000 r/min, the signal is output when actual rotation speed is from 1900 r/min to 2100 r/min. Setting range is from 0 to 100 (r/min). Factory setting is 10 (r/min).

Table 7 3 User Constants Cn-03 through Cn-23 (Constant Setting) List

	User Constant	Symbol	Name	Unit	Lower Limit	Upper Limit	Setting Prior to Shipment	Remarks
Gain Constants	Cn-03	VREFGN	Speed Reference Adjustment Gain	(r/min)/V	10	2162	Rated Speed/6 V	
	Cn-04	LOOPHZ	Speed Loop Gain	Hz	1	2000	80	*
	Cn-05	PITIME	Speed Loop Integration Time Constant	ms	2	10000	20	
	Cn-1A	POSGN	Position Loop Gain	1/s	1	500	40	‡
Torque Constants	Cn-06	EMGTRQ	Emergency Stop Torque	%	0	Max Torque	Max Torque	OT ^{Note} Mode
	Cn-08	TLMTF	Forward Running Torque Limit	%	0	Max Torque	Max Torque	Note
	Cn-09	TLMTR	Reverse Running Torque Limit	%	0	Max Torque	Max Torque	Note
	Cn-13	TCRFGN	Torque Reference Gain	$\frac{1}{10}$ V/ Rated Torque	10	100	30	
	Cn-14	TCRLMT	Speed Limit with Torque Control I	r/min	0	Max Speed	Max Speed	
	Cn-17	TRQFIL	Torque Reference Filter Time Constant	100 μ s	0	250	4	
	Cn-18	CLMIF	Forward External Current Limit	%	0	Max Torque	100	Note
	Cn-19	CLMIR	Reverse External Current Limit	%	0	Max Torque	100	Note
Sequence Constants	Cn-07	SFSACC	Soft Start Time (Acceleration)	ms	0	10000	0	#
	Cn-23	SFSDEC	Soft Start Time (Deceleration)	ms	0	10000	0	#
	Cn-0B	TGONLV	Zero-speed Level	r/min	1	Max Speed	20	
	Cn-0F	ZCLVL	Zero-clamp Level	r/min	0	16383	10	
	Cn-22	VCMPV	Speed Coincidence Signal Output Width	r/min	0	100	10	
	Cn-12	BRKTIM	Delay Time from Braking Reference to SVOFF	10 ms	0	50	0	

Note 100% = rated torque

* Factory setting of Cn-04 (speed loop gain) is determined by the following conditions
 $\text{Load inertia} \leq \text{motor inertia} \times 3$

Be sure to set the value of Cn-04 to 40 or less when motor is rotated without load. If the value has been kept at the factory setting, the motor may oscillate.

† After modifying Cn-0A (PG division ratio setting), and Cn-11 (Number of Encoder Pulses setting) turn OFF power and start up again. The modified value takes effect only after restarting.

‡ Cn-1A (position loop gain) is required when zero-clamp function is used.

When soft start function is used, both Cn-07 and Cn-23 should be set.

Table 7 3 User Constants Cn-03 through Cn-23 (Constant Setting) List (Cont'd)

	User Constant	Symbol	Name	Unit	Lower Limit	Upper Limit	Setting Prior to Shipment	Remarks
Sequence Constants	Cn-15	BRKSPD	Brake Timing at Motor Rotation (Speed level at which brake reference is output)	r/min	0	Max Speed	100	
	Cn-16	BRKWAI	Brake Timing at Motor Rotation (Waiting time from SVOFF to brake reference output)	10 ms	10	100	50	
Encoder Pulse Constants	Cn-0A	PGRAT	PG Dividing Ratio	P/R	16	32768	Encoder Number of Pulses 2048	†
	Cn-11	PULSNO	Number of Encoder Pulses	P/R	513	32768	Encoder Number of Pulses 2048	
Other Constants	Cn-0C	TRQMSW	Mode Switch (Torque Reference)	%	0	Max Torque	200	Note
	Cn-0D	REFMSW	Mode Switch (Speed Reference)	r/min	0	Max Speed	0	
	Cn-0E	ACCMSW	Mode Switch (Motor Acceleration Detection)	10 (r/min)/s	0	3000	0	
	Cn-10	JOGSPD	JOG Speed	r/min	0	Max Speed	500	
	Cn-1F	SPEED1	1st Speed	r/min	0	Max Speed	100	
	Cn-20	SPEED2	2nd Speed	r/min	0	Max Speed	200	
	Cn-21	SPEED3	3rd Speed	r/min	0	Max Speed	300	

Note 100% = rated torque

* Factory setting of Cn-04 (speed loop gain) is determined by the following conditions

$$\text{Load inertia} \leq \text{motor inertia} \times 3$$

Be sure to set the value of Cn-04 to 40 or less when motor is rotated without load. If the value has been kept at the factory setting, the motor may oscillate.

† After modifying Cn-0A (PG division ratio setting), and Cn-11 (Number of Encoder Pulses setting) turn OFF power and start up again. The modified value takes effect only after restarting.

‡ Cn-1A (position loop gain) is required when zero-clamp function is used.

When soft start function is used, both Cn-07 and Cn-23 should be set.

Table 7 4 User Constant Cn-01 (Memory Switch) List

Selection	Bit No	Setting	Conditions	Standard
Sequence Input Selection	0	0	Servo ON/OFF by external input (SV-ON)	0
		1	The servo is ON at all times	
	1 (ABSO PG only)	0	The external input (SEN) is used	0
		1	Regardless of the SEN signal presence, SGD SERVOPACK automatically concludes that the "H" level prevails	
	2	0	The P-OT signal prohibits forward running	0
		1	Forward running is permitted at all times	
3	0	The N-OT signal permits reverse running	0	
	1	Reverse running is permitted at all times		
Sequence Output Signal Changeover (TGON)	4	0	$\overline{\text{TGON}}$ signal is used as a signal output when rotation is detected ($\overline{\text{TGON}}$)	0
		1	$\overline{\text{TGON}}$ signal is used as a signal when current limit is detected	
Treatment of Momentary Power Loss Reset	5	0	Maintains the servo alarm status at momentary power loss reset	0
		1	Releases the servo alarm status automatically at momentary power loss reset	
Fault Stop Selection	6	0	<DB stop> The dynamic brake stops the motor	0
		1	<Coasting to a stop> The motor is freed and brought to a stop	
	7	0	<DB OFF after DB stop> The dynamic brake is turned OFF after the motor is stopped	1
		1	<DB continuously ON after DB stop> The dynamic brake remains activated after the motor is stopped	
	8*	0	The overtravel status stop method coincides with bit 6	0
		1	<Overtravel zero speed stop> In the overtravel status, the motor is stopped at the torque setting defined by user constant Cn-06	
	9†	0	In the overtravel status, base blocking (BB) is implemented after the motor stops	0 1
		1	In the overtravel status, zero clamping is effected after zero speed stop	
Mode Switch Selection	D·C‡	0 0	<Torque reference> Based on the torque reference level defined by user constant Cn-0C	00
		0 1	<Speed reference> Based on the speed reference level defined by user constant Cn-0D	
		1 0	<Acceleration> Based on the acceleration level defined by user constant Cn-0E	
		1 1	<None> The mode switch function is not provided	
Encoder Selection	E	0	Incremental encoder	0
		1	Absolute encoder	
—	F		Don't change	0

* The fault stop method in the torque control mode complies with bit 6

† Selects the status based on the stop method selected for the overtravel status (bit 8)

‡ Selects the mode switch operating condition. When the mode switch operates, the speed control mode changes from P I control to P control (Effective only for speed control)

When the setting of user constant Cn-01 is changed, turn OFF the power supply once and restart the operation

Table 7 4 User Constant Cn-01 (Memory Switch) List (Cont'd)

Selection	Bit No	Setting	Description	Reference Input	Sequence Signal Input	Standard
Control Mode Selection	B · A	0 0	<p><Speed control></p> <ul style="list-style-type: none"> Regular speed control The P-CON signal (1CN-15) is used to effect P/PI control changeover 	Speed reference (V-REF)	P-CON OFF PI control ON P control	0 · 0
		0 1	<p><Zero clamp speed control></p> <ul style="list-style-type: none"> After the motor is stopped (ZCLVL), the speed reference is disconnected to execute the zero speed stop function. After this, it maintains the servo lock status. The P-CON signal (1CN-15) is used to turn the zero clamp function ON and OFF. 		P-CON OFF Zero clamp function OFF ON Zero clamp function ON	
		1 · 0	<p><Torque control I ></p> <ul style="list-style-type: none"> The motor output torque is controlled by the torque reference (T-REF) The V-REF cannot be used 	Torque reference (T-REF)	None	
		1 1	<p><Torque control II ></p> <ul style="list-style-type: none"> The P-CON signal (1CN-15) is used for torque/speed control mode changeover <p>Torque control mode</p> <ul style="list-style-type: none"> The motor output torque is controlled by the torque reference (T-REF) The speed limit can be entered from outside (V-REF). The V-REF voltage (+) limits both the forward and reverse running speeds. <p> MOTOR SPEED </p>  <p>Speed control mode</p> <ul style="list-style-type: none"> The speed reference is entered from the V-REF The T-REF cannot be used 	<p>At torque control</p> <p>Torque reference (T-REF) Speed reference (V-REF)</p> <p>At speed control</p> <p>Speed reference (V-REF)</p> <p>Notes</p> <ul style="list-style-type: none"> If speed goes beyond the limit negative feedback of torque in proportion to speed difference from limit speed occurs to restore moderate speed. Therefore, width of actual motor rotation speed limit depends on load conditions. In case of continuous regeneration (tension control) Please contact your local YASKAWA representative. 	P-CON OFF Torque control ON Speed control	

Table 7 5 User Constant Cn-02 (Memory Switch) List

Selection	Bit No	Setting	Description	Standard
Reverse Rotation Mode	0	0	CCW Forward running	0
		1	CW Forward running	
Home Position Error Mask	1 (ABSO) (PG only)	0	Home position error is detected	0
		1	Home position error is not detected	
Contact Reference Mode	2	0	Contact inputs P-CL and N-CL are used as power supply limit ON/OFF reference inputs Contact input P-CON is used as a signal specified in bit A or B of user constant Cn-01	0
		1	Contact inputs $\overline{P-CL}$ and $\overline{N-CL}$ are used as speed input reference selection (1st to 3rd speed) signals	

Note Turn OFF the power supply after setting

8. DIGITAL OPERATOR (TYPES : JUSP-OP02A-1, 03A)

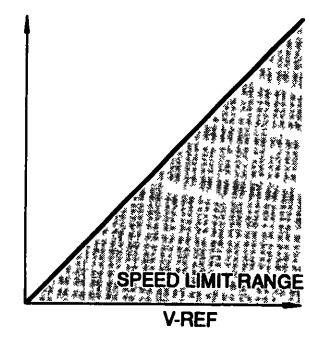
8A. DIGITAL OPERATOR (TYPE : JUSP-OP02A-1) OPERATION METHOD

8A.1 SWITCH OPERATION

Fig 8A 1 shows the digital operator. The digital operator has various functions as listed by modes in Par 8A 2, "DIGITAL OPERATOR FUNCTIONS "

Notes

- 1 The data set by the digital operator is retained in SERVOPACK even after the power is turned OFF
- 2 Even if the power is turned OFF after fault occurrence, the fault data is retained in memory. Therefore, it is possible to check the fault data after the power is turned back ON
- 3 The monitor mode can be changed even during operations

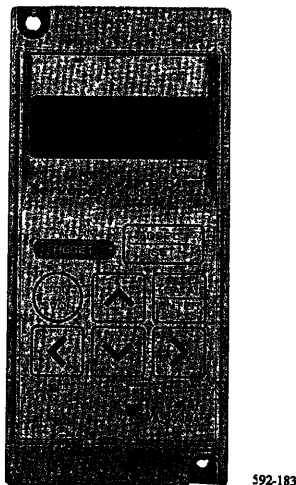
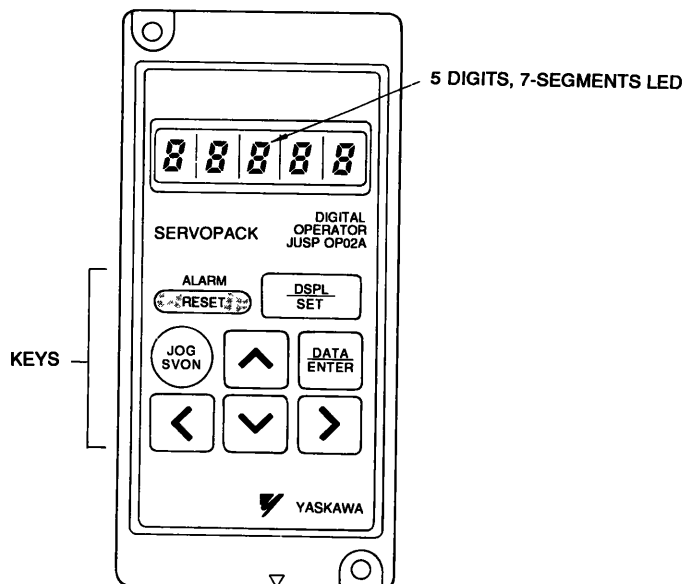

Fig 8A 1 Digital Operator (Hand-held Type)



8A.2 DIGITAL OPERATOR FUNCTIONS

Table 8A 1 shows the digital operator's functions. The status display is the default when control power is turned ON. To change the mode, use  key as shown in Fig 8A 2

Table 8A 1 Digital Operator Functions

Mode	Function
Status Indication Mode	Various Status Indications • Base Block • On Operation • Fault (See Par 8A 3)
Setting Mode	Refer to "User Constant Setting" (See Par 8A 4 1) • Operation (JOG) from digital operator (See Par 8A 4 3) • Speed Reference/Torque Reference Offset Adjustment (See Par, 8A 4 4) • Clearing Fault Traceback Data (See Par 8A 4 5) • Check of Motor Parameters (See Par 8A 4 7) • Auto Tuning (See Par 8A 4 8) • Check of Software Version (See Par 8A 4 9)
Monitor Mode	Various Monitoring • Speed • Speed Reference • Torque Reference • Number of Pulses from Origin (Phase-U) • Electrical Angle • Internal Status Bit (See Par 8A 5)
Fault Traceback Indication Mode	Fault History (See Par 8A 6)

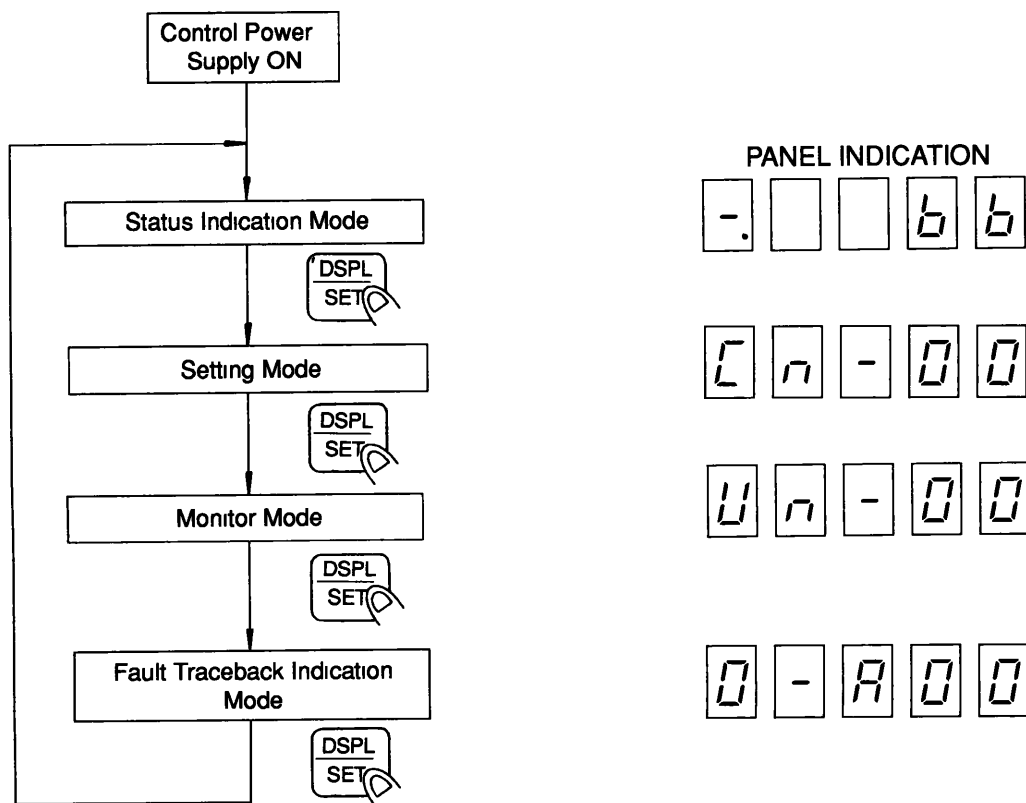



Fig 8A 2 Mode Changeover

8A.3 STATUS INDICATION MODE

When this mode is selected, the condition of SERVOPACK is indicated with bits and codes as shown in Fig 8A 3 Table 8A 2 shows the bit data contents Table 8A 3 shows the codes and conditions

-  . Alarm reset switch
-  . Changes status indication mode into setting mode.

Panel Display

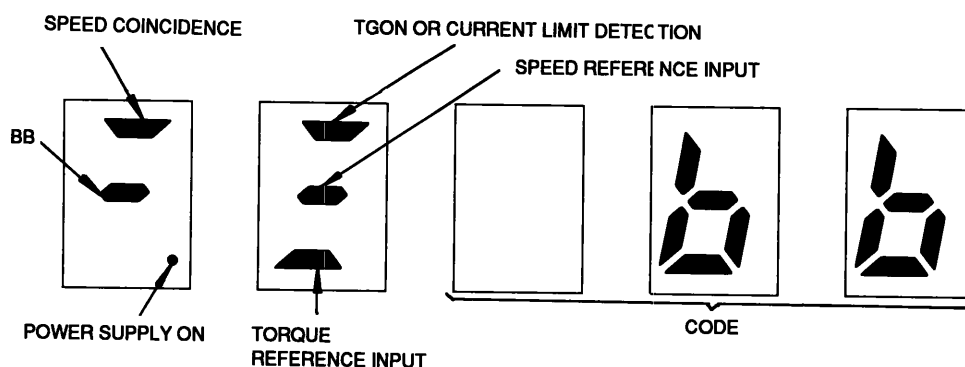

Fig 8A 3 Status Indication Mode

Table 8A 2 Bit Data Contents

Bit Data	Contents	Remarks
Power Supply ON	Light goes ON with power supply ON	
BB	Light goes ON with base block, and goes OFF with servo ON	
Speed Coincidence	Light goes ON when motor rotating speed reaches internal speed reference	
TGON	Light goes ON with motor rotating speed higher than TGON level (Standard setting is 20 r/min)	Selected by bit 4 of user constant Cn-01
Current Limit Detection	Light goes ON when torque reference reaches the torque limit value (TGON or current limit detection is displayed according to bit 4 of user constant Cn-01)	
Speed Reference Input	Light goes ON with speed reference input equal to or higher than 1% of max speed	
Torque Reference Input	Light goes ON with torque reference input more than 10% of rated torque	Only at torque control

Table 8A 3 Codes and Status

Code	Status
<i>bb</i>	Base Block
<i>run</i>	On Operation
<i>pot</i>	Forward Running Prohibited
<i>not</i>	Reverse Running Prohibited
<i>R00</i>)	Alarm Status Refer to Table 8A 6

8A.4 SETTING MODE

In this mode, the following operations can be performed

- User constant setup and monitor
- Jog operations from the digital operator
- Offset adjustment
- Fault traceback data clearing
- Check of motor parameters
- Auto tuning
- Check of software version

8A.4.1 User Constant (Data) Setup and Monitor (Cn-03 to Cn-23)

Panel Display

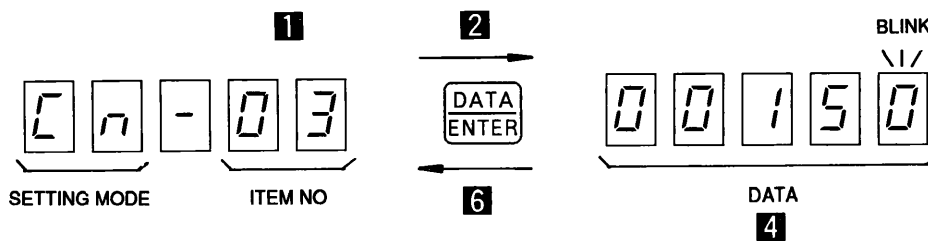

















Fig 8A 4 User Constant Setting

- 1** Set up the item number with the , , , or  key
 - With the  or  key, choose a setup digit. The chosen digit starts blinking to indicate that its numerical value can be changed.
 - With the  or  key, increase or decrease the numerical value until the desired value is obtained.
- 2** With the  key, display the data related to the selected item number.
- 3** With the , , , or  key, set up the data (The same operation as stated in **1**).
- 4** Retain the data with the  key.
- 5** With the  key, return to the item No. display status.
- 6** Repeat steps **1** through **5** as needed.
- 7** Using the  key, switch from the setting mode to the monitor mode.

For details, see Table 7 3, "User Constants Cn-03 through Cn-23 (Constant Setting) List "

8A.4.2 User Constant (Memory Switch) Setup and Monitor (Cn-01 and Cn-02)

User constants Cn-01 and Cn-02 can be set up or monitored as memory switch bits. The procedures for item number setup and data display are the same as indicated in Par 8A 4 1 1 and 2.

Panel Display

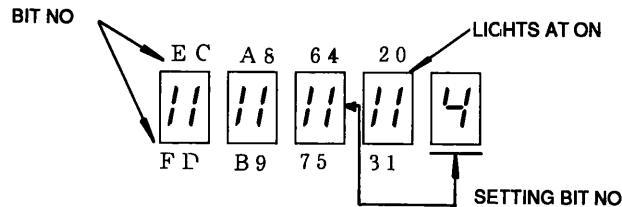

Fig 8A 5 Bit Date Display









- 1 With the  or  key, enter the setup memory switch bit No at the far right end of the panel
- 2 With the  key, set the memory switch to ON or OFF (either  or  can be used) The panel indication comes on when the switch is ON, and goes off when the switch is OFF
- 3 Repeat steps 1 and 2 as needed
- 4 Retain the data with the  key
- 5 With the  key, return to the item No display status
- 6 Using the  key, switch from the setting mode to the monitor mode

Table 7 4 shows memory switches of user constant Cn-01, and Table 7 5 those of user constant Cn-02

8A.4.3 Digital Operator Jog Operation Mode Selection and Operating Procedure

(1) Digital Operator Jog Operation Mode Selection

When user constant Cn-00 is set to 00, the operations are to be controlled from the digital operator

Panel Display

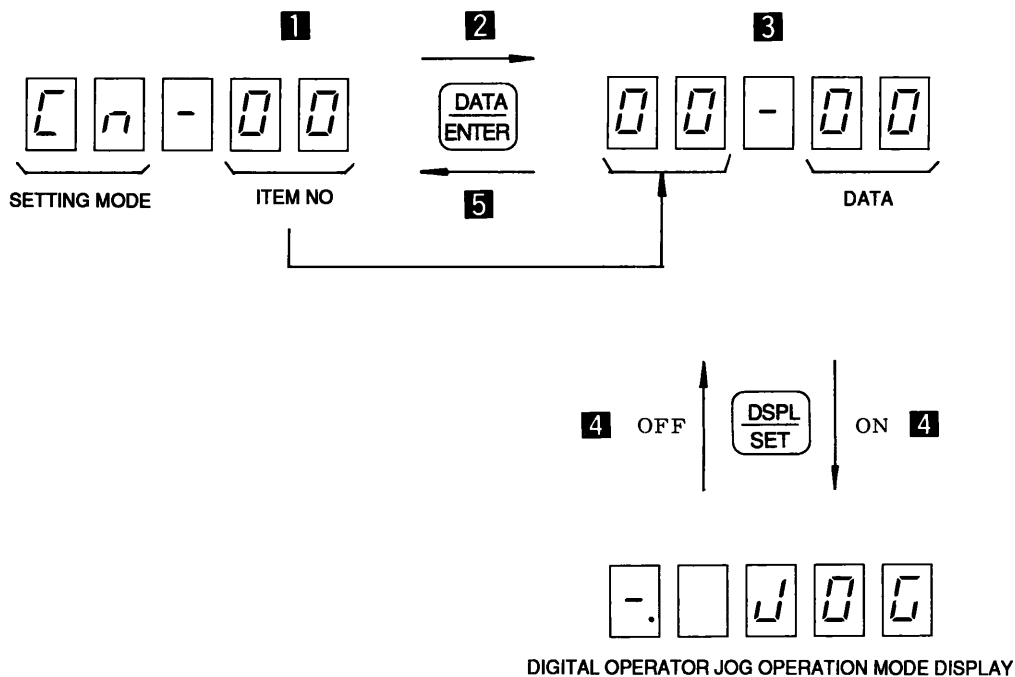

















Fig 8A 6 Digital Operator Jog Operation Mode

- 1 Select the item number 00 with the , ,  or  key
- 2 With the  key, display the data related to the selected item number
- 3 With the , ,  or  key, select the number 00
- 4 With the  key, turn ON or OFF the monitor panel jog operation mode
- 5 With the  key, return to the item No display status
- 6 Using the  key, switch from the setting mode to the monitor mode

(2) Digital Operator Jog Operation Procedure

For speed reference adjustment, use user constant Cn-10 (see Table 7.3)

- 1 With the  switch, effect SVON/SVOFF changeover
- 2 The motor runs in the forward direction while the  key is held down
- 3 The motor runs in the reverse direction while the  key is held down

8A.4.4 Speed Reference Offset Adjustment

When user constant Cn-00 is set to 01, the system enters the speed reference offset adjustment mode

Panel Display

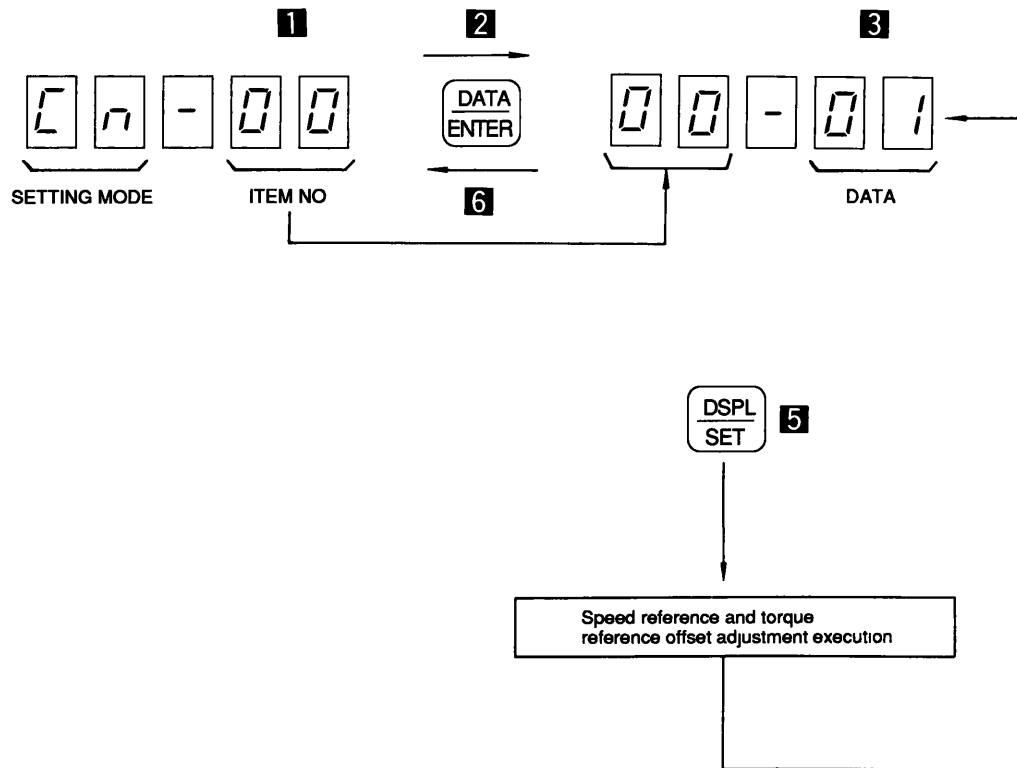













Fig 8A 7 Speed Reference Offset Adjustment

- 1 Select the item number 00 with the , ,  or  key
- 2 With the  key, display the data related to the selected item number
- 3 With the , ,  or  key, select the number 01
- 4 Apply the desired zero speed reference voltage with speed reference input Apply the desired zero torque reference voltage with torque reference input
- 5 With the  key, make speed reference offset adjustment and return to the user constant Cn-00 data display status
- 6 With the  key, return to the item No display status
- 7 Using the  key, switch from the setting mode to the monitor mode

8A.4.5 Clearing Fault Traceback Data

When user constant Cn-00 is set to 02, fault traceback data are cleared

Panel Display

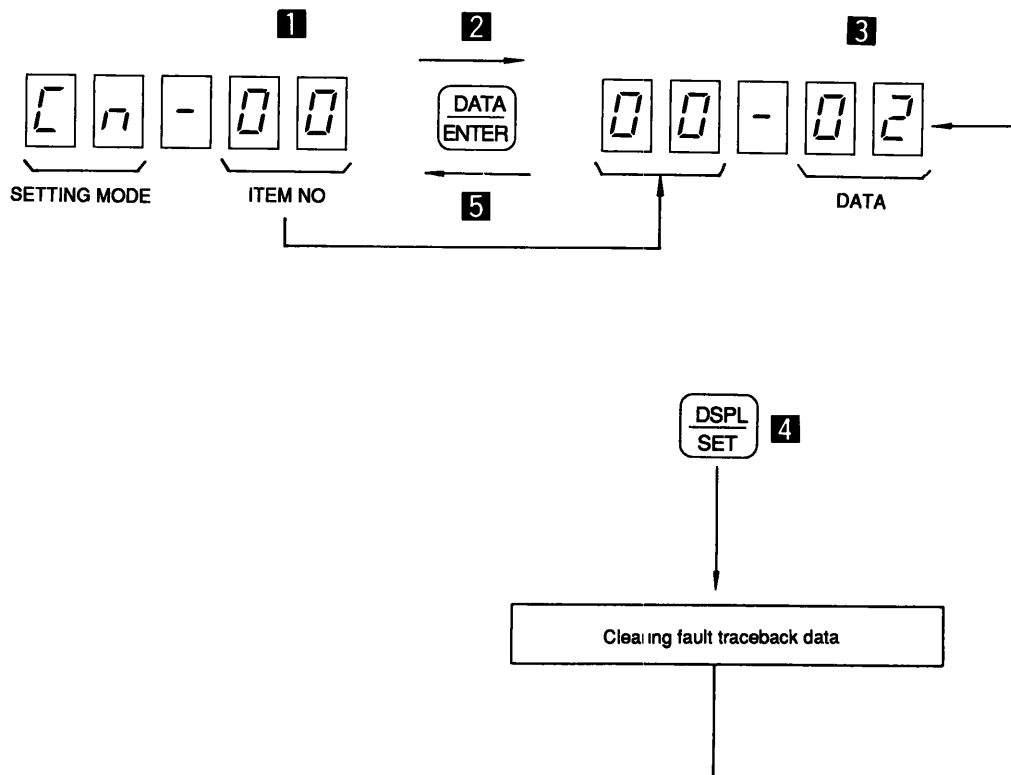













Fig 8A 8 Clearing Fault Traceback Data

- 1** Select the item number 00 with the  ,  ,  or  key
- 2** With the  key, display the data related to the selected item number
- 3** With the  ,  ,  or  key, select the number 02
- 4** With the  key, clear fault traceback data and return to the user constant Cn-00 data display status.
- 5** With the  key, return to the item No display status
- 6** Using the  key, switch from the setting mode to the monitor mode

8A.4.6 Speed Reference Offset Manual Adjustment

(1) Mode Setting in Speed Reference Offset Manual Adjustment

When user constant Cn-00 is set to 03, the system enters the speed reference offset manual adjustment mode

Panel Display

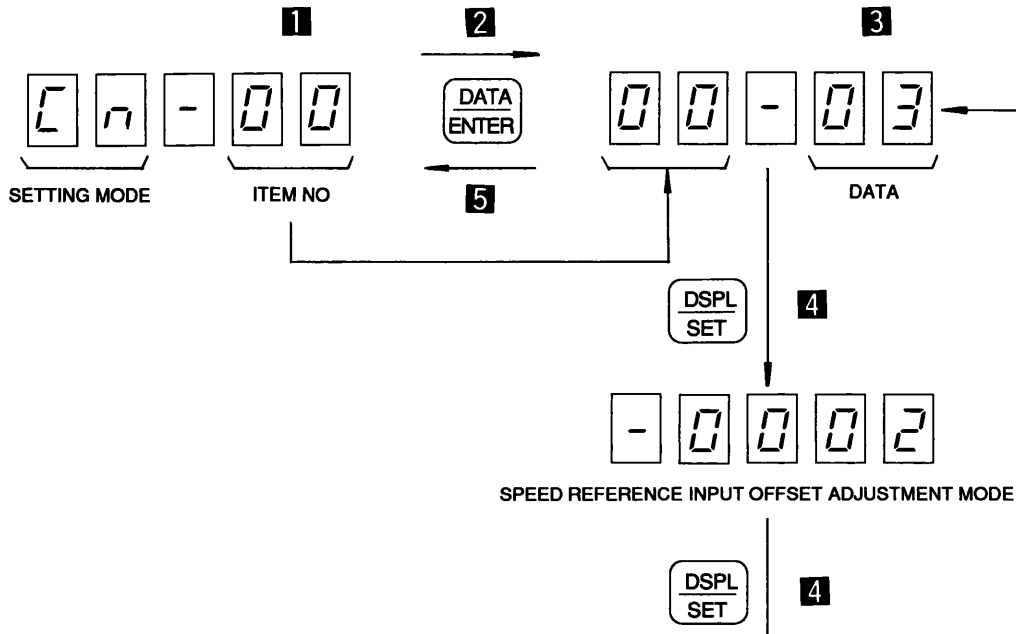

















Fig 8A 9 Speed Reference Offset Manual Adjustment Mode

- 1 Set up item number 00 with the  ,  ,  or  key
- 2 With the  key, display the data related to the selected item number
- 3 With the  ,  ,  or  key, select the number 03
- 4 With the  key, switch the adjustment mode
- 5 With the  key, return to the item No display status
- 6 Using the  key, switch from the setting mode to the monitor mode

(2) Speed Reference Offset Manual Adjustment

Input a voltage that will obtain zero speed reference to the speed reference input. Input a voltage that will obtain zero torque reference to the torque reference input (Normally 0 V)

- 1 While the  key is held down, the offset is added to the forward running side
- 2 While the  key is held down, the offset is added to the reverse running side
- 3 Using the  key, store offset data, then enter the monitor mode

Offset adjustment is performed so that the LED indication may basically become zero, however, the perfect zero status of indication does not always offer optimum adjustment. Therefore, adjust the offset carefully, taking actual motor rotation into consideration.

8A.4.7 Check of Motor Parameters

(1) Check Method of Motor Parameters

When user constant Cn-00 is set to 04, the system enters the motor parameter check mode

Panel Display

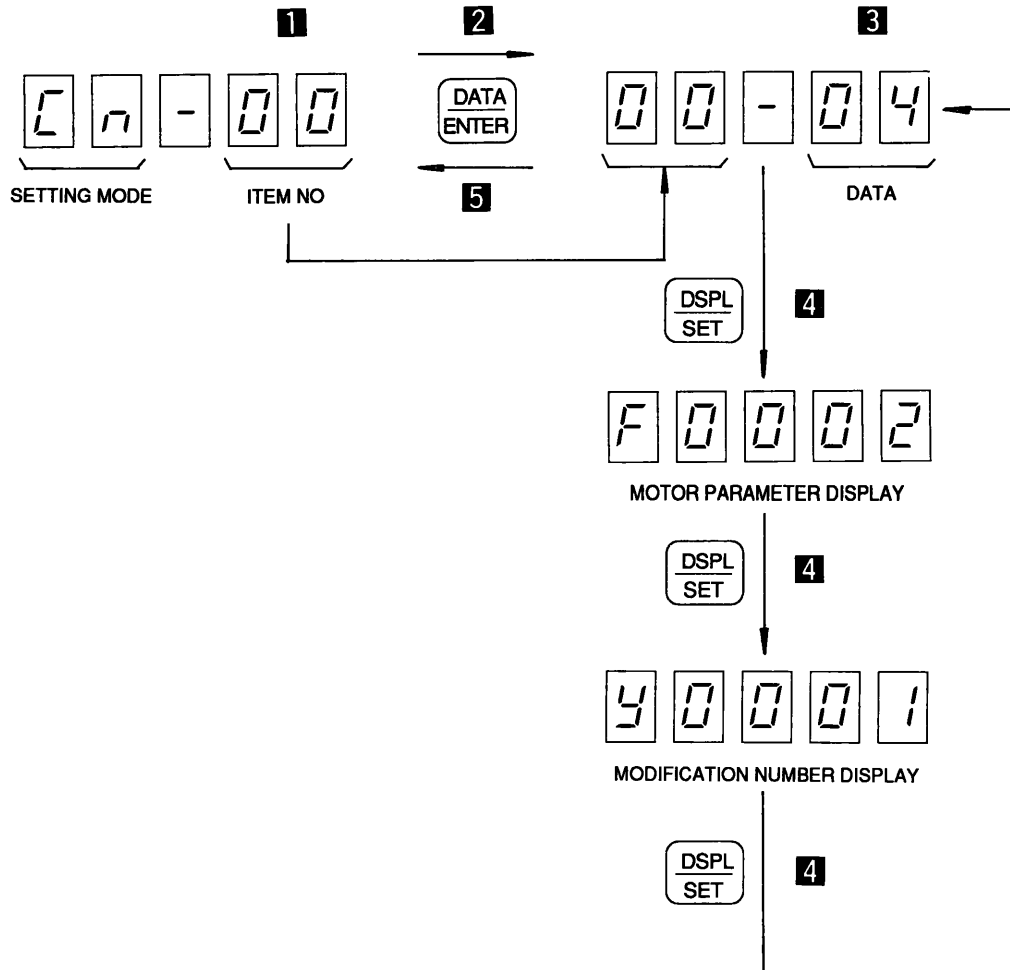













Fig 8A 10 Switch Functions in Motor Parameter Check

- 1** Set up item number 00 with the , ,  or  key
- 2** With the  key, display the data related to the selected item number
- 3** With the , ,  or  key, select the number 04
- 4** With the  key, check the motor parameter
- 5** With the  key, return to the item No display status
- 6** Using the  key, switch from the setting mode to the monitor mode

(2) Parameter Display

Motor Parameter

F. 0 0 0 2

Motor Capacity

9E	30 W (0.04HP)
b2	50 W (0.07HP)
01	100 W (0.13HP)
02	200 W (0.27HP)
04	400 W (0.53HP)
08	750 W (1.01HP)

Motor Type

0	Σ Series, 200 V
1	Σ Series, 100 V

Modification Index

5. a b c d

Modification No (Hexadecimal display)

$$(a \times 16^3 + b \times 16^2 + c \times 16 + d) = \text{Modification No}$$

Nos Corresponding to Alphabets

A	= 10
b	= 11
C	= 12
d	= 13
E	= 14
F	= 15

8A.4.8 Auto Tuning

(1) Mode Setting in Auto Tuning

When user constant Cn-00 is set to 05, the system enters the auto tuning mode

Panel Display

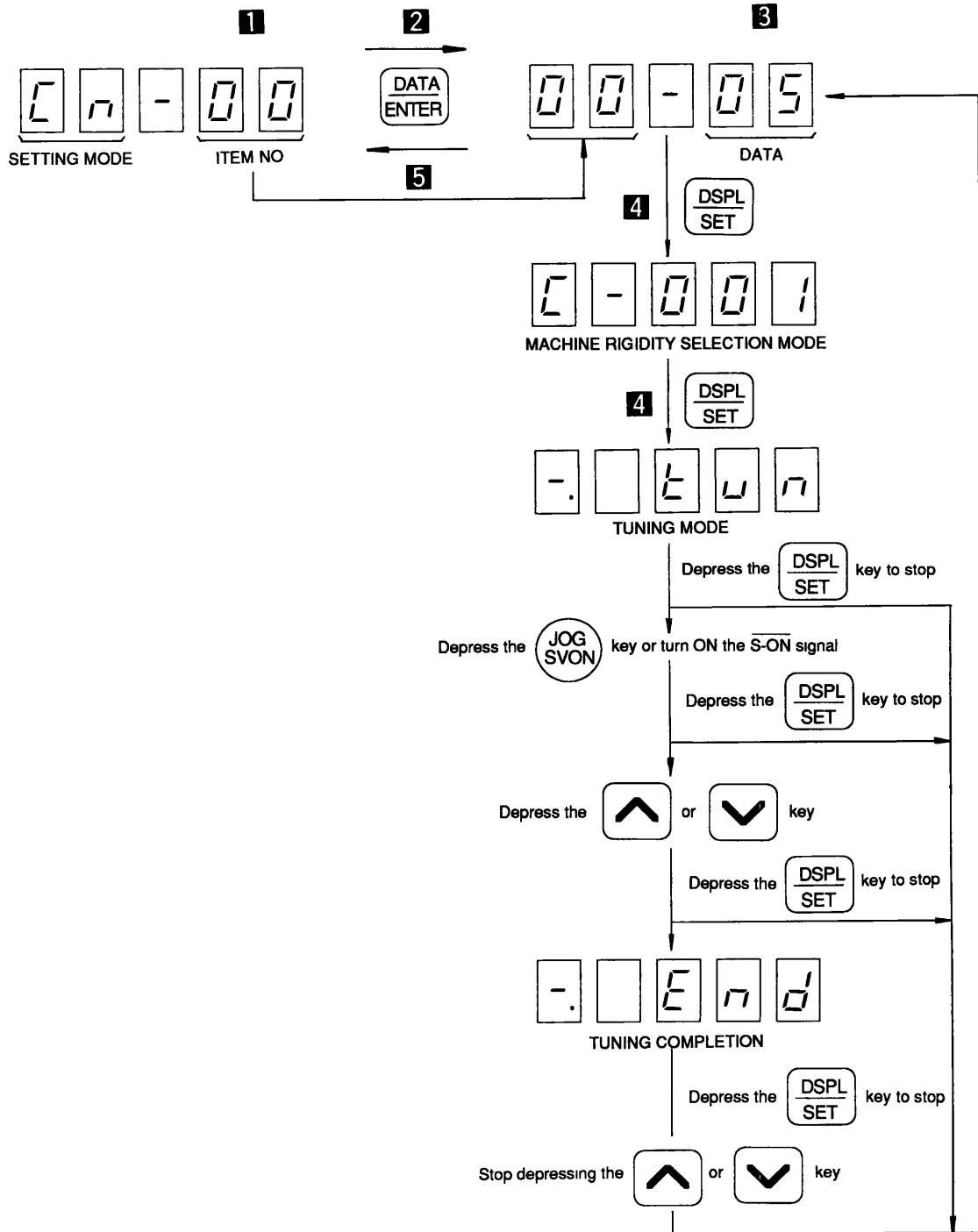















Fig 8A 11 Auto Tuning Mode

- 1 Set up item number 00 with the  ,  ,  or  key
- 2 With the  key, display the data related to the selected item number
- 3 With the  ,  ,  or  key, select the number 05
- 4 With the  key, switch to the machine registry selection mode or tuning mode
- 5 With the  key, return to the item No display status
- 6 Using the  key, switch from the setting mode to the monitor mode

(2) Tuning Method

(a) Speed setting





When tuning is being performed, the maximum value of speed reference is set by user constant Cn-10. Set the value to approximately 500 r/min. (If the value is too small, auto tuning cannot be performed properly.)

The motor runs intermittently when the  or  key is held down. (The motor does not run at the same speed continuously.)

(b) Machine rigidity selection

According to the machine rigidity, select the following

     Low response



     Medium response

     High response

When the machine rigidity is not defined, select the middle-speed response

• Machine vibration

When entering the servo ON status with the  switch or machine vibrates

suddenly at depressing the  or  key, depress the  key and stop the tuning operation

Then depress the  key to enter the machine rigidity selection mode, and set the level of machine rigidity selection at one level lower

• When tuning is not completed

When tuning is not completed even though the machine does not vibrate, depress the

 key to stop the tuning operation





Then depress the  key to enter the machine rigidity selection mode and set the level of machine rigidity selection at one level higher

(c) Tuning

1 With the  switch, effect SVON/SVOFF changeover

2 The motor runs in the forward direction while the  key is held down

3 The motor runs in the reverse direction while the  key is held down

Note If the machine vibrates when depressing the  or  key, stop depressing the  or  key since the gain is decreased

4 With the tuning completion,  is displayed and power supply to the motor is stopped

Stop depressing the  or  key Display is returned to 

(d) Input signals

• In the auto tuning mode, OT signal is effective

Make sure to input OT signal

When absolute encoder is used, SEN signal is also effective and should be input

When these signals are not used, set the bits of 1, 2 and 3 of user constant Cn-01 to 1 respectively

• During overtravel (OT signal is OFF), auto tuning cannot be performed

Perform auto tuning when the driven part of the machine is not in the overtravel position

• When performing auto tuning, make sure to keep the $\overline{\text{P-CON}}$ signal OFF (PI control status)

• When $\overline{\text{S-ON}}$ signal is used, display the  and turn ON the signal

8A.4.9 Check of Software Version

(1) Mode Setting in Software Version Check

When user constant Cn-00 is set to 06, the system enters the software version check mode

Panel Display

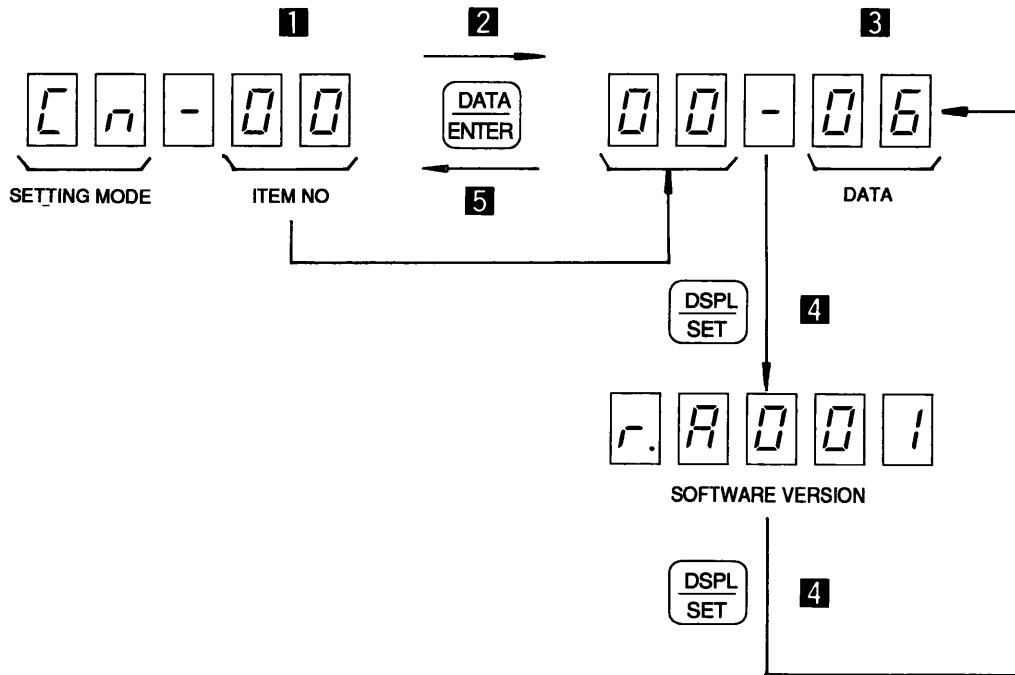











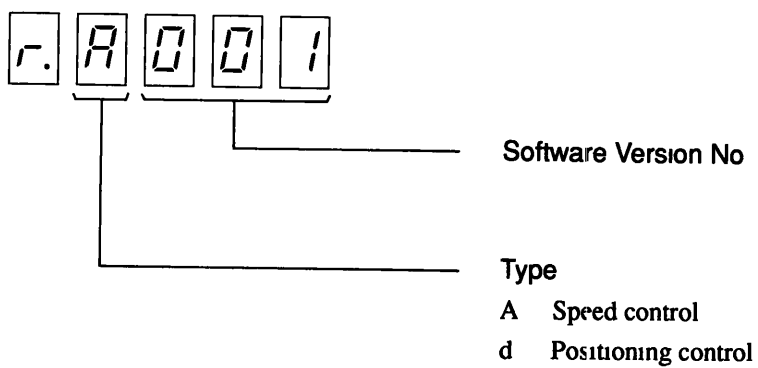

Fig 8A 12 Software Version Check Mode

- 1 Set up item number 00 with the  ,  ,  or  key
- 2 With the  key, display the data related to the selected item number
- 3 With the  ,  ,  or  key, select the number 06
- 4 With the  key, display the software version
- 5 With the  key, return to the item No display status
- 6 Using the  key, switch from the setting mode to the monitor mode

(2) Software Version Display



8A.5 MONITOR MODE

In this mode, the speed reference, torque reference, and other data can be monitored on the digital operator

Table 8A 4 lists the data that can be monitored

Table 8A 4 Data Monitored

Monitor No	Data Monitored
00	Feedback Speed (r/min)
01	Speed Reference (r/min)
02	Torque Reference (%)
03	No of Pulses from Phase-U edge
04	Electrical Angle (deg)
05	Internal Status Bit Display 1 (Refer to Table 8A 5)

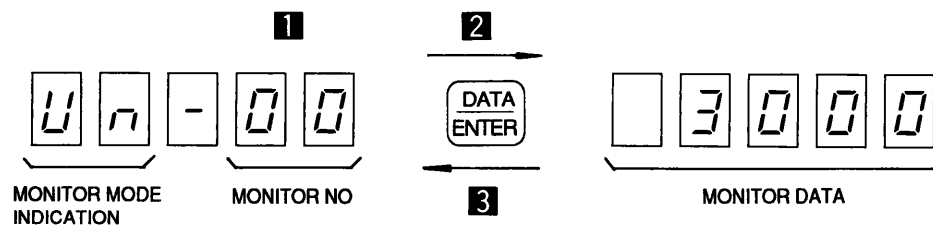

Fig 8A 13 Switch Functions in Monitor Mode





- 1 With the  or  key, select a desired monitor No
- 2 With the  key, initiate monitor display
- 3 Using the  key, return to the monitor No selection status
- 4 With the  key, switch from the monitor mode to the fault traceback mode

Table 8A 5 Bit Indication of Monitor Mode Un-05 Internal Status



Bit No	Symbol	Contents	Remarks	
①	SVALM	Turns ON at servo alarm		
②	DBON	Turns ON at dynamic braking		
③	DIR	Turns ON in reverse run mode		
④	TGON CLT	Turns ON at motor running (Motor speed is TGON level or higher) Turns ON during current limit	Select by setting of bit 4 of user constant Cn-01	
⑤	V-CMP	Turns ON speed coincidence		
⑥	MSON	Turns ON at mode switch ON		
⑦	P-CL	Turns ON during forward current limit		
⑧	N-CL	Turns ON during reverse current limit		
⑨	B-ON	Motor under Current Conduction		
⑩	PA	Phase-A	Turns OFF when input signal is at high level	
⑪	PB	Phase-B		
⑫	PC	Phase-C		
⑬	PU	Phase-U		Incremental encoder only
⑭	PV	Phase-V		Incremental encoder only
⑮	PW	Phase-W		Incremental encoder only
⑯	SVON	Turns ON at SVON signal is ON		
⑰	P-CON	Turns ON during poperation input	Select by setting of bit A or B of user constant Cn-01 or bit 2 of user constant Cn-02	
	ZCLMP	Zero clamp operation		
	DR	Rotating direction input by external setting speed (ON at reverse, OFF at forward)		
⑱	P-OT	Turns ON at forward running prohibit input		
⑲	N-OT	Turns ON at reverse running prohibit input		
⑳	SEN	Turns ON at SEN signal input	Absolute encoder only	

8A. 6 FAULT TRACEBACK MODE

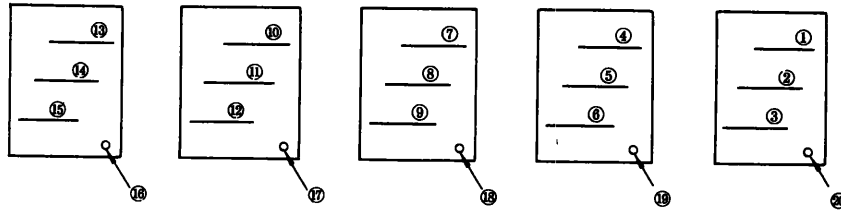
In this mode, information on past fault occurrences can be displayed

- Information on up to 10 past fault occurrences can be stored
- When a fault is reset or the control power is turned ON, traceback data A 99 is saved (These data are also counted as one of a total of 10 stored items of fault information)
- For the relationship between traceback data and fault descriptions, refer to Table 8A 6

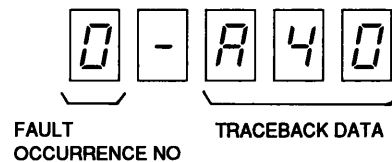

Fig 8A 14 Fault Traceback Mode



- 1 With the  or  key, increase or decrease the fault occurrence number
The fault information related to the selected number is then displayed (The higher the fault occurrence number, the older the fault occurrence)
- 2 With the  key, switch from the fault traceback mode to the status display mode

Table 8A 6 Error Displays with Digital Operator and Traceback Data

Digital Operator (Traceback Data)	Detection	Remarks
<i>A00</i>	Absolute Encoder Data Error	Only when absolute encoder is used
<i>A02</i>	Parameter Breakdown	
<i>A04</i>	Parameter Setting Error	
<i>A.10</i>	Overcurrent or Heatsink Overheat or Ground Fault	
<i>A40</i>	Overvoltage	
<i>A5 1</i>	Feedback Overspeed	Detected at 110% of max speed
<i>A52</i>	Overspeed Reference Input	Detected at 110% of max speed
<i>A.7 1</i>	Overload	Momentary overload
<i>A.72</i>	Overload	Continuous overload
<i>A80</i>	Encoder Error	Only when absolute encoder is used
<i>A8 1</i>	Encoder Backup Alarm	Only when 12-bit absolute encoder is used
<i>A82</i>	Encoder Checksum Error	Only when 12-bit absolute encoder is used
<i>A83</i>	Encoder Battery Alarm	Only when 12-bit absolute encoder is used
<i>A84</i>	Encoder Absolute Error	Only when 12-bit absolute encoder is used
<i>A85</i>	Encoder Overspeed	Only when 12-bit absolute encoder is used
<i>A6 1</i>	Reference Input Read Error	
<i>AC 1</i>	Overrun	
<i>AC2</i>	Phase Detection Error	Only when incremental encoder is used
<i>AC3</i>	PA-, PB-phase Disconnection of PG Signal Line	
<i>AC4</i>	PC Disconnection of PG signal Line	
<i>AF3</i>	Momentary Power Loss Alarm	Detected when power is turned ON again during power holding time
<i>A.99</i>	Not Applicable to Alarm Alarm Reset, Power ON	Only for traceback data
<i>CPF00</i>	Digital Operator Transmission Error 1	Digital operator error Not detected as traceback data
<i>CPF0 1</i>	Digital Operator Transmission Error 2	

8B. DIGITAL OPERATOR (TYPE : JUSP-OP03A) OPERATION METHOD

8B.1 SWITCH OPERATION

Fig 8B 1 shows the digital operator. The digital operator has various functions as listed by modes in Par 8B 2, "DIGITAL OPERATOR FUNCTIONS"

Notes

- 1 The data set by the digital operator is retained in SERVOPACK even after the power is turned OFF
- 2 Even if the power is turned OFF after fault occurrence, the fault data is retained in memory. Therefore, it is possible to check the fault data after the power is turned back ON
- 3 The monitor mode can be changed even during operations

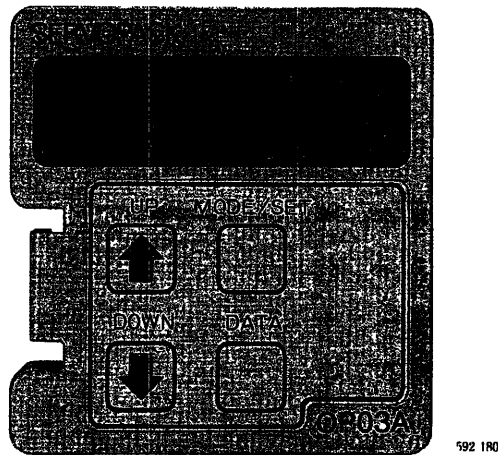
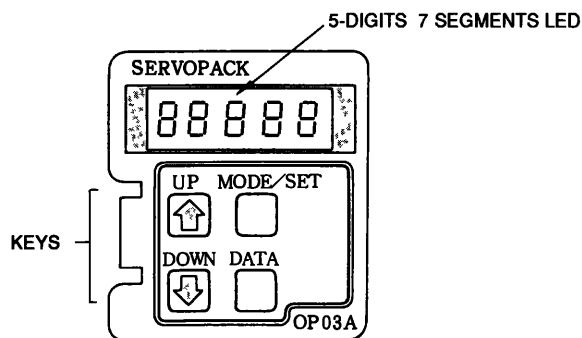

Fig 8B 1 Digital Operator (Mounted Type)



8B.2 DIGITAL OPERATOR FUNCTIONS

Table 8B 1 shows the digital operator's functions. The status display is the default when control power is turned ON. To change the mode, use  key as shown in Fig 8B 2

Table 8B 1 Digital Operator Functions

Mode	Function
Status Indication Mode	Various Status Indications • Base Block • On Operation • Fault (See Par 8B 3)
Setting Mode	Refer to "User Constant Setting" (See Par 8B 4 1) • Operation (JOG) from digital operator (See Par 8B 4 3) • Speed Reference/Torque Reference Offset Adjustment (See Par, 8B 4 4) • Clearing Fault Traceback Data (See Par 8B 4 5) • Check of Motor Parameters (See Par 8B 4 7) • Auto Tuning (See Par 8B 4 8) • Check of Software Version (See Par 8B 4 9)
Monitor Mode	Various Monitoring • Speed • Speed Reference • Torque Reference • Number of Pulses from Origin (Phase-U) • Electrical Angle • Internal Status Bit (See Par 8B 5)
Fault Traceback Indication Mode	Fault History (See Par 8B 6)

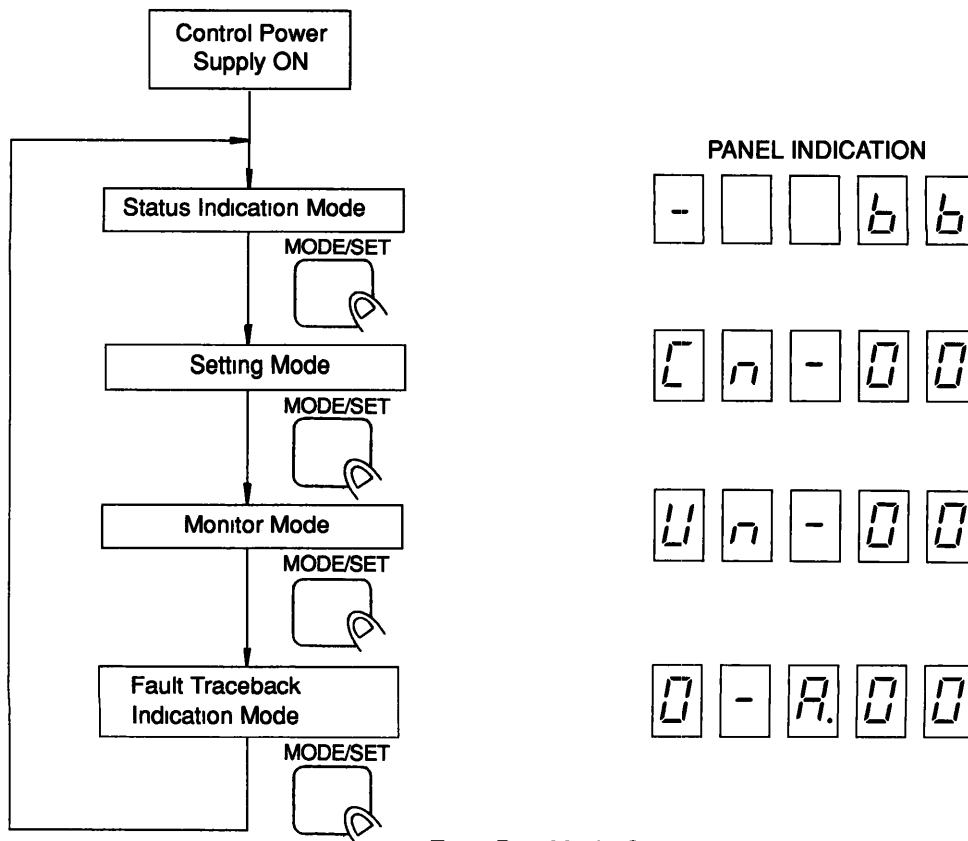
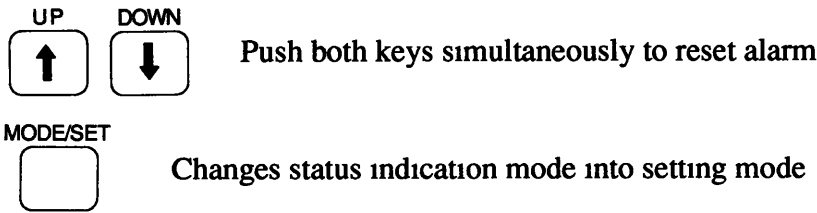

Fig 8B 2 Mode Changeover

8B.3 STATUS INDICATION MODE

When this mode is selected, the condition of SERVOPACK is indicated with bits and codes as shown in Fig 8B 3 Table 8B 2 shows the bit data contents Table 8B 3 shows the codes and conditions.



Panel Display

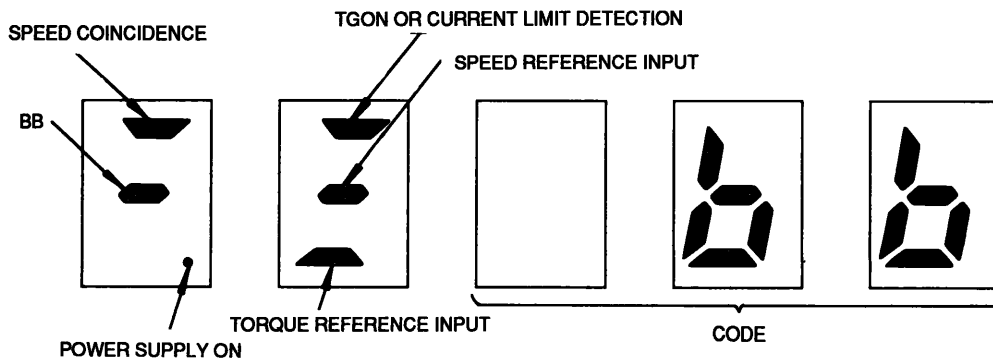

Fig 8B 3 Status Indication Mode

Table 8B 2 Bit Data Contents

Bit Data	Contents	Remarks
Power Supply ON	Light goes ON with power supply ON	
BB	Light goes ON with base block, and goes OFF with servo ON	
Speed Coincidence	Light goes ON when motor rotating speed reaches internal speed reference	
TGON	Light goes ON with motor rotating speed higher than TGON level (Standard setting is 20 r/min)	Selected by bit 4 of user constant Cn-01
Current Limit Detection	Light goes ON when torque reference reaches the torque limit value (TGON or current limit detection is displayed according to bit 4 of user constant Cn-01)	
Speed Reference Input	Light goes ON with speed reference input equal to or higher than 1% of max speed	
Torque Reference Input	Light goes ON with torque reference input more than 10% of rated torque	Only at torque control

Table 8B 3 Codes and Status

Code	Status
<i>bb</i>	Base Block
<i>run</i>	On Operation
<i>For</i>	Forward Running Prohibited
<i>rev</i>	Reverse Running Prohibited
<i>ALM</i>	Alarm Status Refer to Table 8B 6

8B.4 SETTING MODE

In this mode, the following operations can be performed

- User constant setup and monitor
- Jog operations from the digital operator
- Offset adjustment
- Fault traceback data clearing
- Check of motor parameters
- Auto tuning
- Check of software version

8B.4.1 User Constant (Data) Setup and Monitor (Cn-03 to Cn-23)

Panel Display

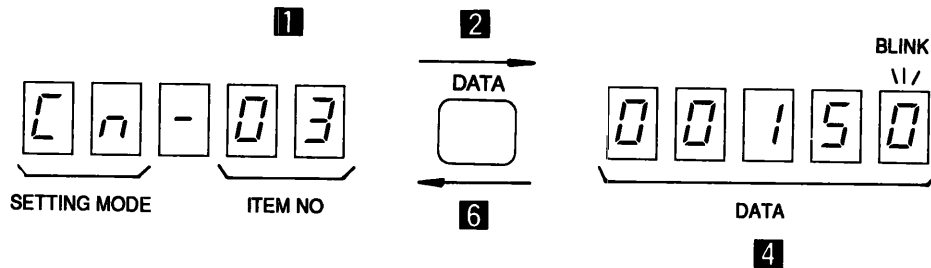





Fig 8B 4 User Constant Setting

- 1** Set up the item number with the  or  key

While the key is held down, the numerical value increases or decreases successively by one

- 2** With the  key, display the data related to the selected item number

- 3** With the  or  key, set up the data (The same operation as stated in **1**)

While the key is held down, the numerical value increases or decreases successively by one

Holding down the key increases or decreases the number in increments of 10. Keeping the key held down changes the increment unit to 100, 1000 to 10000

- 4 Retain the data with the ^{MODE/SET} key
- 5 With the ^{DATA} key, return to the item No display status
- 6 Repeat steps 1 through 5 as needed
- 7 Using the ^{MODE/SET} key, switch from the setting mode to the monitor mode

For details, see Table 7 3, "User Constants Cn-03 through Cn-23 (Constant Setting) List"

8B.4.2 User Constant (Memory Switch) Setup and Monitor (Cn-01 to Cn-02)

User constants Cn-01 and Cn-02 can be set up or monitored as memory switch bits. The procedures for item number setup and data display are the same as indicated in Par 8B 4 1 **1** and **2**.

Panel Display

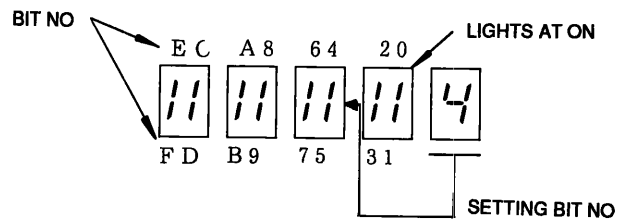

Fig 8B 5 Bit Data Display

- 1** With the or key, enter the setup memory switch bit No at the far right end of the panel
- 2** With the key, set the memory switch to ON or OFF. The panel indication comes on when the switch is ON, and goes off when the switch is OFF
- 3** Repeat steps **1** and **2** as needed
- 4** Retain the data with the key
- 5** With the key, return to the item No display status
- 6** Using the key, switch from the setting mode to the monitor mode

Table 7.4 shows memory switches of user constant Cn-01, and Table 7.5 those of user constant Cn-02.

8B.4.3 Digital Operator Jog Operation Mode Selection and Operating Procedure

(1) Digital Operator Jog Operation Mode Selection

When user constant Cn-00 is set to 00, the operations are to be controlled from the digital operator

Panel Display

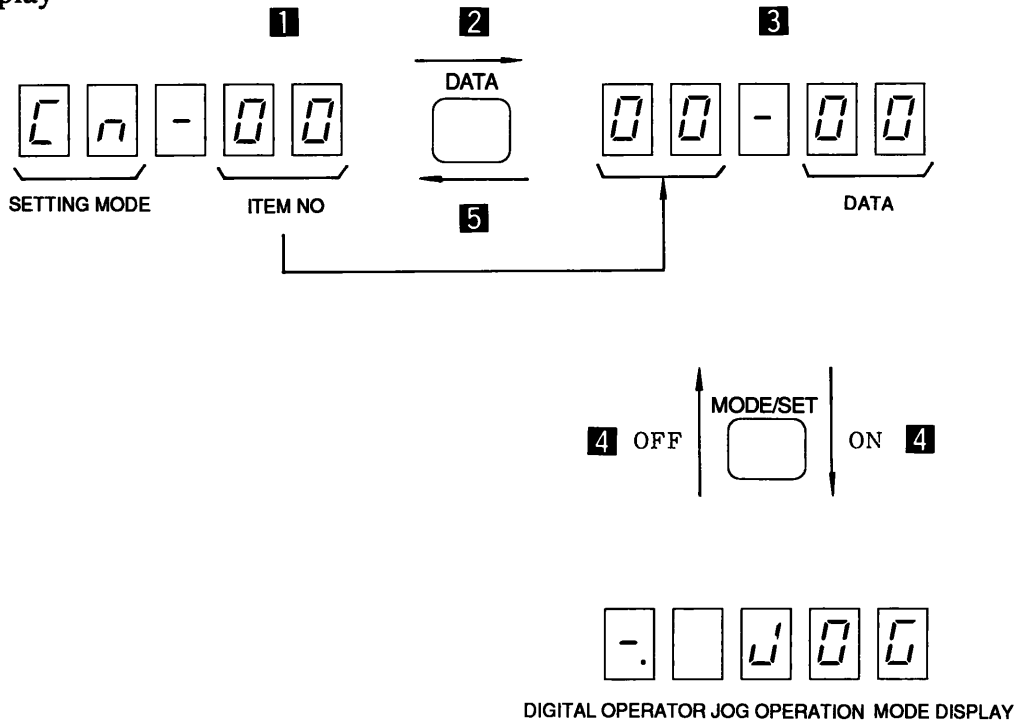













Fig 8B 6 Digital Operator Jog Operation Mode

- 1** Select the item number 00 with the  or  key
- 2** With the  key, display the data related to the selected item number
- 3** With the  or  key, select the number 00
- 4** With the  key, turn ON or OFF the monitor panel jog operation mode
- 5** With the  key, return to the item No display status
- 6** Using the  key, switch from the setting mode to the monitor mode

(2) Digital Operator Jog Operation Procedure

For speed reference adjustment, use user constant Cn-10 (see Table 7.3)

- 1 With the  key, effect SVON/SVOFF changeover
- 2 The motor runs in the forward direction while the  key is held down
- 3 The motor runs in the reverse direction while the  key is held down

8B.4.4 Speed Reference Offset Adjustment

When user constant Cn-00 is set to 01, the system enters the speed reference offset adjustment mode

Panel Display

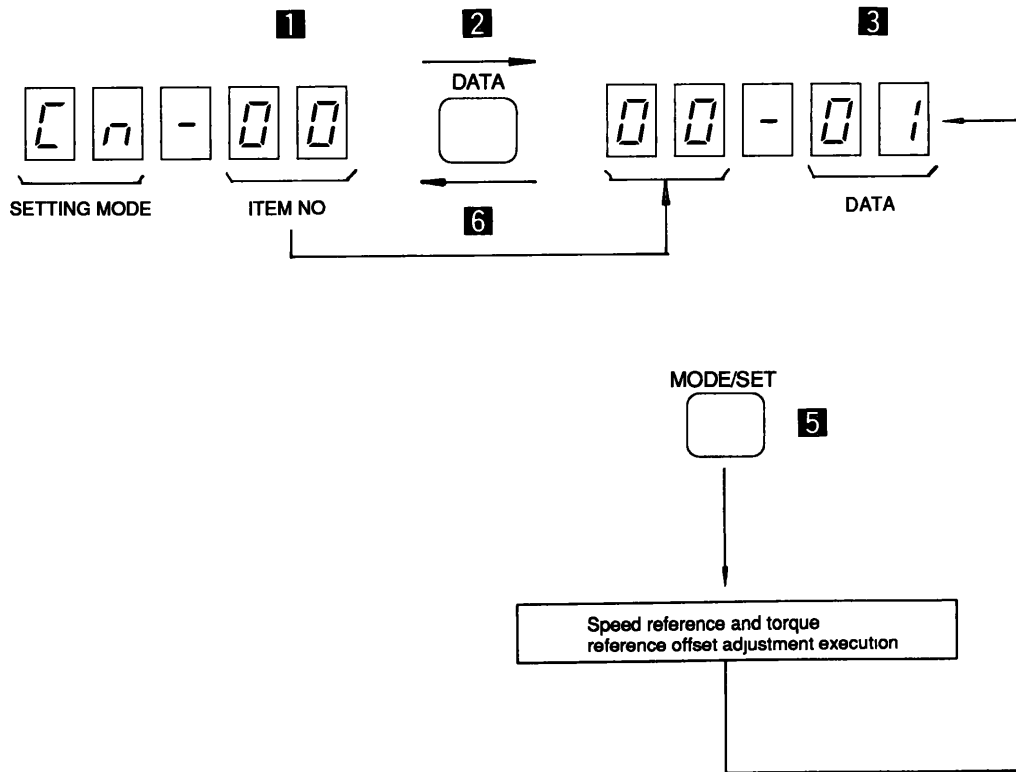









Fig 8B 7 Speed Reference Offset Adjustment

- 1 Select the item number 00 with the  or  key
- 2 With the  key, display the data related to the selected item number
- 3 With the  or  key, select the number 01
- 4 Apply the desired zero speed reference voltage with speed reference input Apply the desired zero torque reference voltage with torque reference input
- 5 With the  key, make speed reference offset adjustment and return to the user constant Cn-00 data display status
- 6 With the  key, return to the item No display status
- 7 Using the  key, switch from the setting mode to the monitor mode

8B.4.5 Clearing Fault Traceback Data

When user constant Cn-00 is set to 02, fault traceback data are cleared

Panel Display

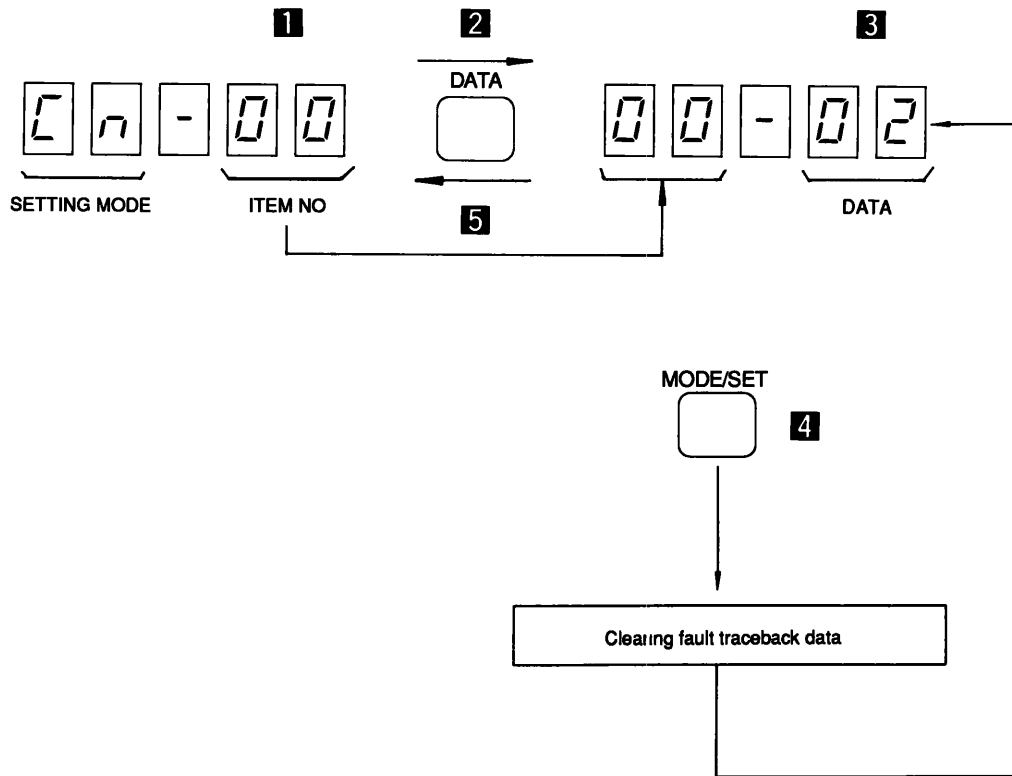

Fig 8B 8 Clearing Fault Traceback Data

- 1 Select the item number 00 with the or key
- 2 With the key, display the data related to the selected item number
- 3 With the or key, select the number 02
- 4 With the key, clear fault traceback data and return to the user constant Cn-00 data display status
- 5 With the key, return to the item No display status
- 6 Using the key, switch from the setting mode to the monitor mode

8B.4.6 Speed Reference Offset Manual Adjustment

(1) Mode Setting in Speed Reference Offset Manual Adjustment

When user constant Cn-00 is set to 03, the system enters the speed reference offset manual adjustment mode

Panel Display

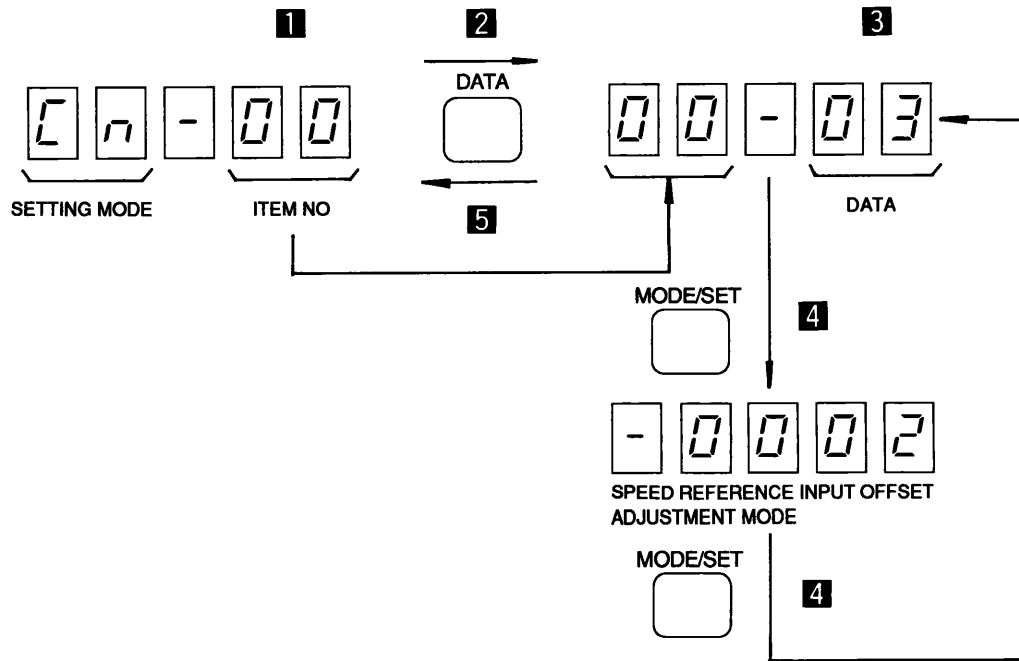













Fig 8B 9 Speed Reference Offset Manual Adjustment Mode

- 1 Set up item number 00 with the  or  key
- 2 With the  key, display the data related to the selected item number
- 3 With the  or  key, select the number 03
- 4 With the  key, switch the adjustment mode
- 5 With the  key, return to the item No display status
- 6 Using the  key, switch from the setting mode to the monitor mode

(2) Speed Reference Offset Manual Adjustment

Input a voltage that will obtain zero speed reference to the speed reference input Input a voltage that will obtain zero torque reference to the torque reference input (Normally 0 V)

- 1 While the  key is held down, the offset is added to the forward running side
- 2 While the  key is held down, the offset is added to the reverse running side
- 3 Using the  key, store offset data, then enter the monitor mode

Offset adjustment is performed so that the LED indication may basically become zero , however, the perfect zero status of indication does not always offer optimum adjustment Therefore, adjust the offset carefully, taking actual motor rotation into consideration

8B.4.7 Check of Motor Parameters

(1) Check Method of Motor Parameters

When user constant Cn-00 is set to 04, the system enters the motor parameter check mode

Panel Display

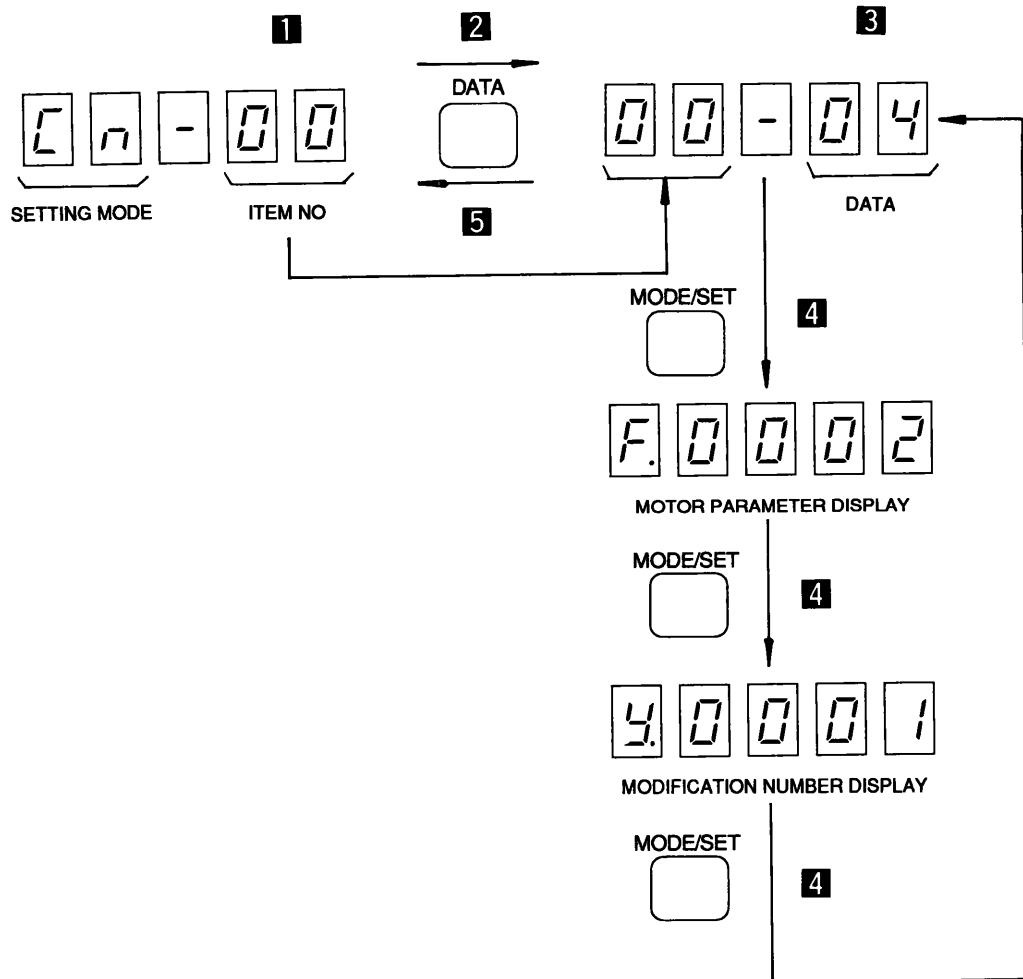









Fig 8B 10 Switch Functions in Motor Parameter Check

- 1 Set up item number 00 with the  or  key
- 2 With the  key, display the data related to the selected item number
- 3 With the  or  key, select the number 04

- 4 With the  key, check the motor parameter
- 5 With the  key, return to the item No display status
- 6 Using the  key, switch from the setting mode to the monitor mode

(2) Parameter Display

· Motor Parameter

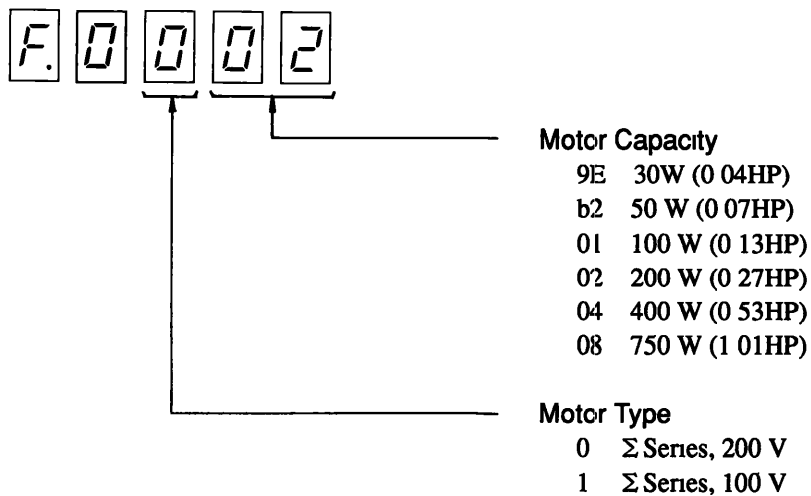

· Modification Index

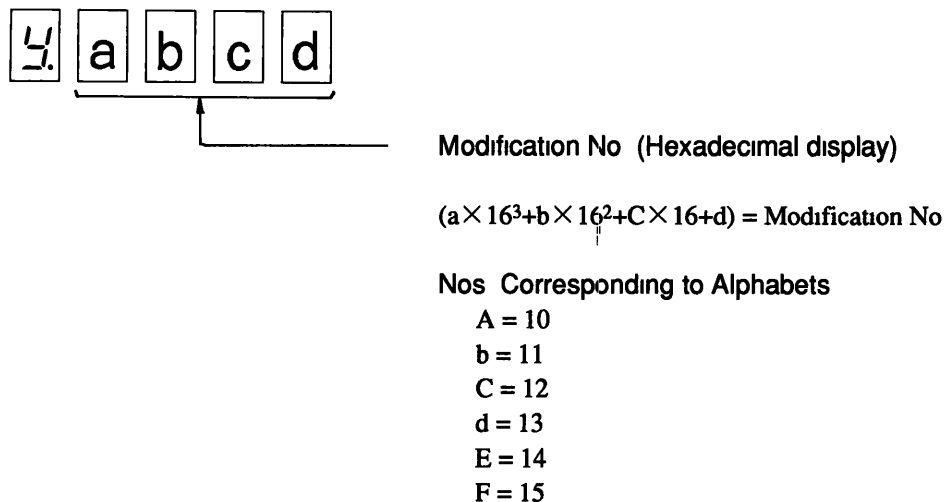

8B.4.8 Auto Tuning

(1) Mode Setting in Auto Tuning

When user constant Cn-00 is set to 05, the system enters the auto tuning mode

Panel Display

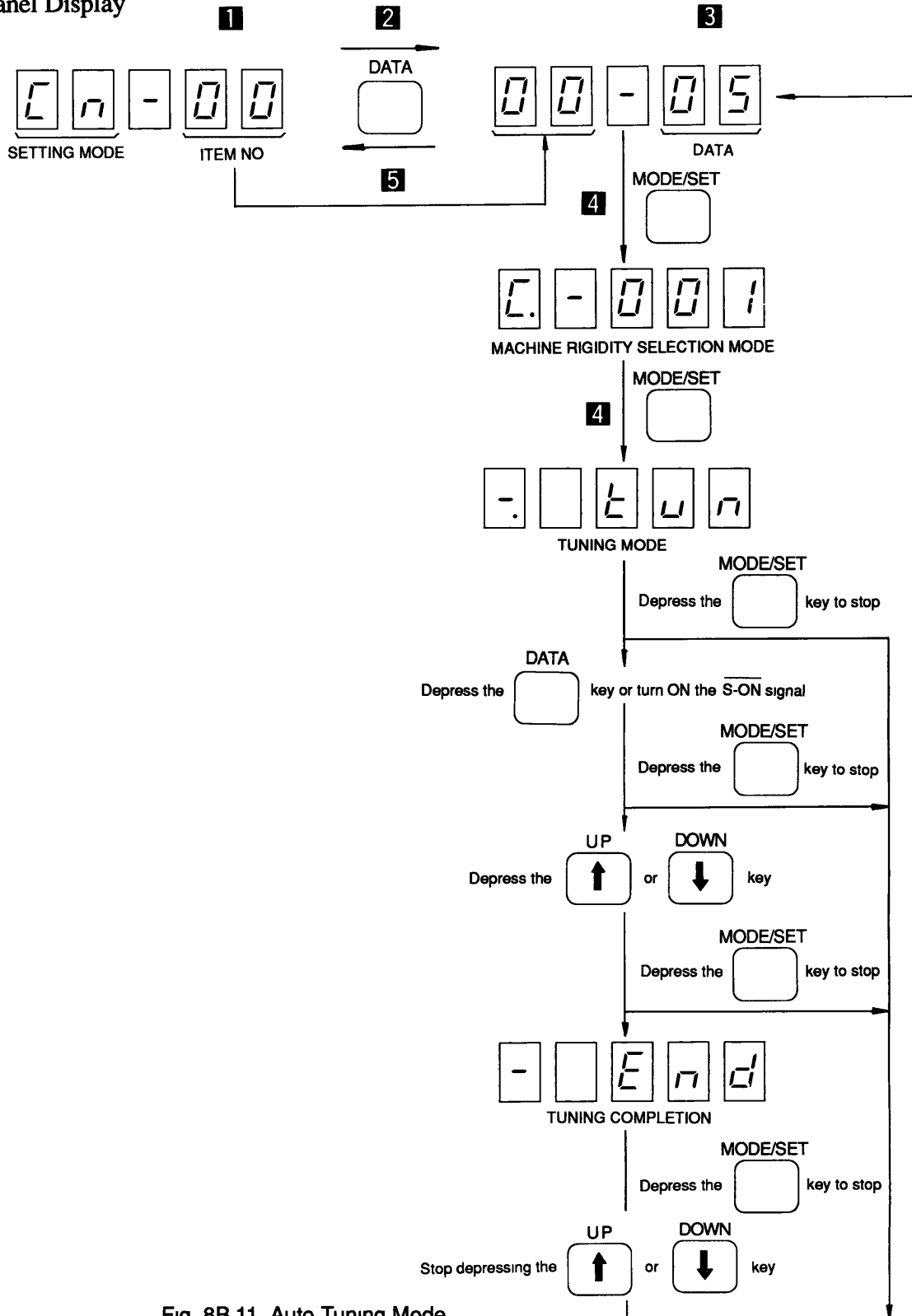









Fig 8B 11 Auto Tuning Mode



- 1 Set up item number 00 with the  or  key
- 2 With the  key, display the data related to the selected item number
- 3 With the  or  key, select the number 05
- 4 With the  key, switch to the machine rigidity selection mode or tuning mode
- 5 With the  key, return to the item No display status
- 6 Using the  key, switch from the setting mode to the monitor mode

(2) Tuning Method

(a) Speed setting

When tuning is being performed, the maximum value of speed reference is set by user constant Cn-10





Set the value to approximately 500 r/min (If the value is too small, auto tuning cannot be performed properly)





The motor runs intermittently when the  or  key is held down (The motor does not run at the same speed continuously)

(b) Machine rigidity selection

According to the machine rigidity, select the following

     Low response



     Medium response

     High response

When the machine rigidity is not defined, select the middle-speed response

• Machine vibration

When entering the servo ON status with the  switch or machine vibrates

suddenly at depressing the  or  key, depress the  key and stop the tuning operation



Then depress the  key to enter the machine rigidity selection mode and set the level of machine rigidity selection at one level lower





• When tuning is not completed

When tuning is not completed even though machine does not vibrate, depress the  key to stop the tuning operation



Then depress the  key to enter the machine rigidity selection mode and set the level of machine rigidity selection at one level higher

(c) Tuning

- 1 With the  switch, effect SVON/SVOFF changeover
- 2 The motor runs in the forward direction while the  key is held down
- 3 The motor runs in the reverse direction while the  key is held down

Note If the machine vibrates when depressing the  or  key, stop depressing the  or  key since the gain is decreased

- 4 With the tuning completion,  is displayed and power supply to the motor is stopped

Stop depressing the  or  key Display is returned to 

(d) Input signals

- In the auto tuning mode, OT signal is effective
Make sure to input OT signal.
When absolute encoder is used, SEN signal is also effective and should be input
When these signals are not used, set the bits of 1, 2 and 3 of user constant Cn-01 to 1 respectively
- During overtravel (OT signal is OFF), auto tuning cannot be performed
Perform auto tuning when the driven part of the machine is not in the overtravel position
- When performing auto tuning, make sure to keep the $\overline{\text{P-CON}}$ signal OFF (PI control status).
- When $\overline{\text{S-ON}}$ signal is used, display the  and turn ON the signal.

8B.4.9 Check of Software Version

(1) Mode Setting in Software Version Check

When user constant Cn-00 is set to 06, the system enters the software version check mode

Panel Display

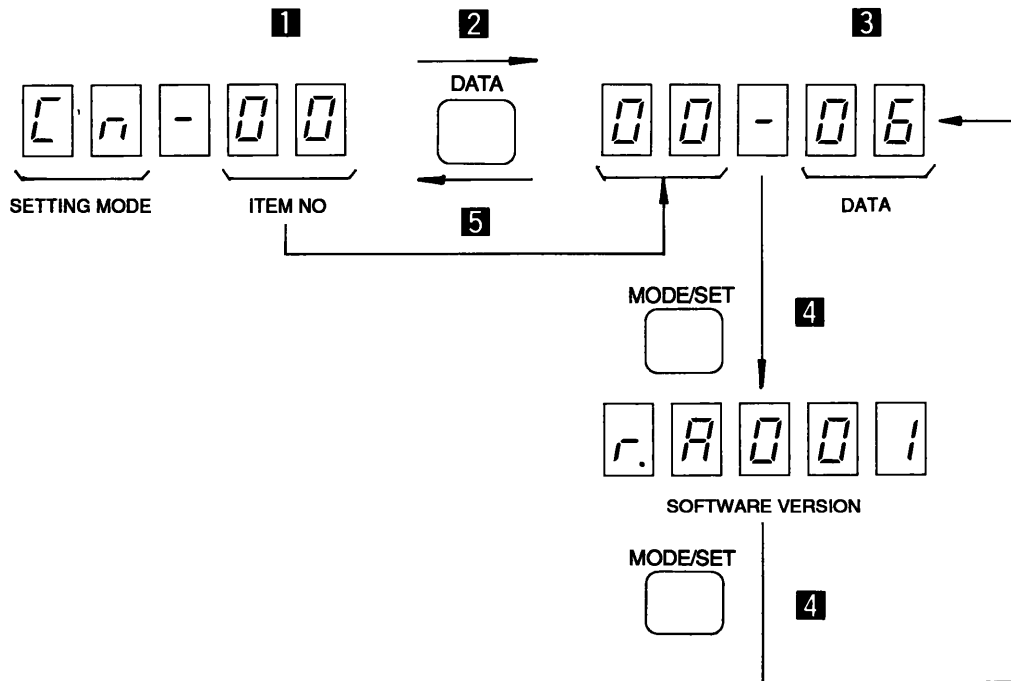







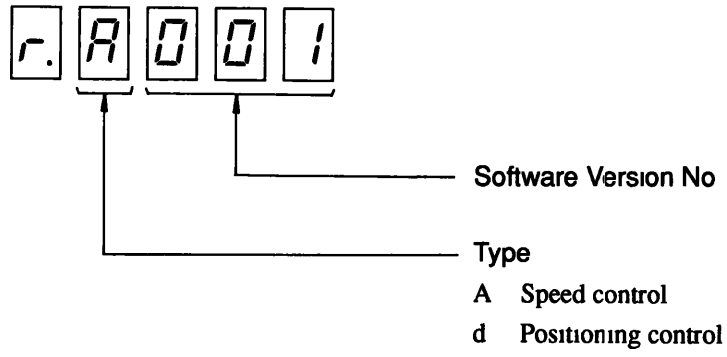

Fig 8B 12 Software Version Check Mode

- 1** Set up item number 00 with the  or  key
- 2** With the  key, display the data related to the selected item number
- 3** With the  or  key, select the number 06
- 4** With the  key, display the software version
- 5** With the  key, return to the item No display status
- 6** Using the  key, switch from the setting mode to the monitor mode

(2) Software Version Display



8B.5 MONITOR MODE

In this mode, the speed reference, torque reference, and other data can be monitored on the digital operator

Table 8B 4 lists the data that can be monitored

Table 8B 4 Data Monitored

Monitor No	Data Monitored
00	Feedback Speed (r/min)
01	Speed Reference (r/min)
02	Torque Reference (%)
03	No of Pulses from Phase-U edge
04	Electrical Angle (deg)
05	Internal Status Bit Display 1 (Refer to Table 8B 5)

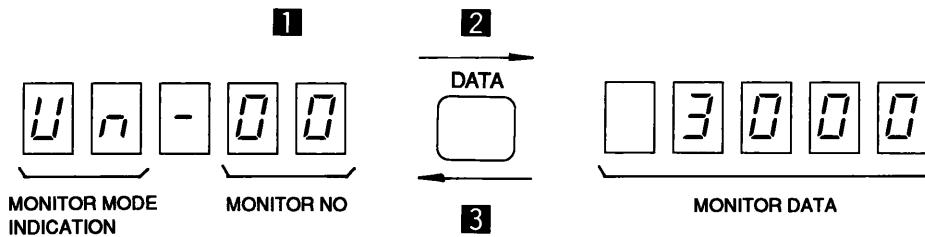

Fig 8A 13 Switch Functions in Monitor Mode





- With the  or  key, select a desired monitor No
- With the  key, initiate monitor display
- Using the  key, return to the monitor No selection status
- With the  key, switch from the monitor mode to the fault traceback mode

Table 8B 5 Bit Indication of Monitor Mode Un-05 Internal Status



Bit No	Symbol	Contents	Remarks	
①	SVALM	Turns ON at servo alarm		
②	DBON	Turns ON at dynamic braking		
③	DIR	Turns ON in reverse run mode		
④	TGON	Turns ON at motor running (Motor speed is TGON level or higher)	Select by setting of bit 4 of user constant Cn-01	
	CLT	Turns ON during current limit		
⑤	V-CMP	Turns ON speed coincidence		
⑥	MSON	Turns ON at mode switch ON		
⑦	P-CL	Turns ON during forward current limit		
⑧	N-CL	Turns ON during reverse current limit		
⑨	B-ON	Motor under Current Conduction		
⑩	PA	Phase-A	Turn OFF when input signal is at high level	
⑪	PB	Phase-B		
⑫	PC	Phase-C		
⑬	PU	Phase-U		Incremental encoder only
⑭	PV	Phase-V		Incremental encoder only
⑮	PW	Phase-W		Incremental encoder only
⑯	SVON	Turns ON at SVON signal is ON		
⑰	P-CON	Turns ON during P operation input	Select by setting of bit A or B of user constant Cn-01 or bit 2 of user constant Cn-02	
	ZCLMP	Zero clamp operation at stopping		
	DR	Rotating direction input by external setting speed (ON at reverse, OFF at forward)		
⑱	P-OT	Turns ON at forward running prohibit input		
⑲	N-OT	Turns ON at reverse running prohibit input		
⑳	SEN	Turns ON at SEN signal input	Absolute encoder only	

8B.6 FAULT TRACEBACK MODE

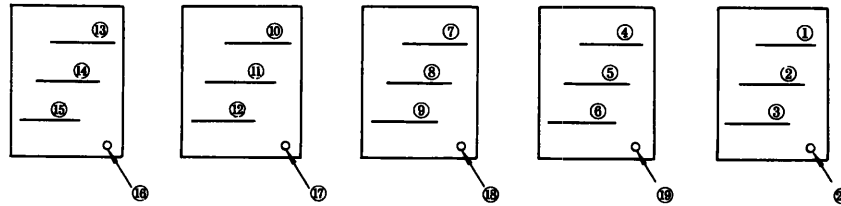
In this mode, information on past fault occurrences can be displayed

- Information on up to 10 past fault occurrences can be stored
- When a fault is reset or the control power is turned ON, traceback data A 99 is saved (These data are also counted as one of a total of 10 stored items of fault information)
- For the relationship between traceback data and fault descriptions, refer to Table 8B 6

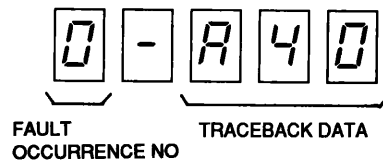

Fig 8B 14 Fault Traceback Mode

- 1 With the or key, increase or decrease the fault occurrence number

The fault information related to the selected number is then displayed (The higher the fault occurrence number, the older the fault occurrence)

- 2 With the key, switch from the fault traceback mode to the status display mode

Table 8B 6 Error Displays with Digital Operator and Traceback Data

Digital Operator (Traceback Data)	Detection	Remarks
<i>R00</i>	Absolute Encoder Data Error	Only when absolute encoder is used
<i>R02</i>	Parameter Breakdown	
<i>R04</i>	Parameter Setting Error	
<i>R.10</i>	Overcurrent or Heatsink Overheat or Ground Fault	
<i>R.40</i>	Overvoltage	
<i>R51</i>	Feedback Overspeed	Detected at 110% of max speed
<i>R52</i>	Overspeed Reference Input	Detected at 110% of max speed
<i>R71</i>	Overload	Momentary overload
<i>R72</i>	Overload	Continuous overload
<i>R80</i>	Encoder Error	Only when absolute encoder is used
<i>R81</i>	Encoder Backup Alarm	Only when 12-bit absolute encoder is used
<i>R82</i>	Encoder Checksum Error	Only when 12-bit absolute encoder is used
<i>R83</i>	Encoder Battery Alarm	Only when 12-bit absolute encoder is used
<i>R84</i>	Encoder Absolute Error	Only when 12-bit absolute encoder is used
<i>R85</i>	Encoder Overspeed	Only when 12-bit absolute encoder is used
<i>Rb1</i>	Reference Input Read Error	
<i>RC1</i>	Overrun	
<i>RC2</i>	Phase Detection Error	Only when incremental encoder is used
<i>RC3</i>	PA-, PB-phase Disconnection of PG Signal Line	
<i>RC4</i>	PC Disconnection of PG Signal Line	
<i>RF3</i>	Momentary Power Loss Alarm	Detected when power is turned ON again during power holding time
<i>R99</i>	Not Applicable to Alarm Alarm Reset, Power ON	Only for traceback data
<i>CPFD0</i>	Digital Operator Transmission Error 1	Digital operator error
<i>CPFD1</i>	Digital Operator Transmission Error 2	Not detected as traceback data

9. INSTALLATION AND WIRING

9.1 RECEIVING

This motor has been put through stringent tests at the factory before shipment. After unpacking, however, check for the following:

- Its nameplate ratings meet your requirements
It has sustained no damage during transportation
- The output shaft can be hand-rotated freely. However, motors with holding brake do not rotate
- Fastening bolts and screws are not loose

If any part of the motor is damaged or lost, immediately contact your YASKAWA representative giving full details and nameplate data.

9.2 INSTALLATION

9.2.1 SGM SERVOMOTOR

AC SERVOMOTOR can be installed either horizontally or vertically.

(1) Before Mounting

Wash off anticorrosive paint on shaft extension and flange surface with thinner before connecting the motor to the driven machine. Do not subject other parts of the motor to thinner.

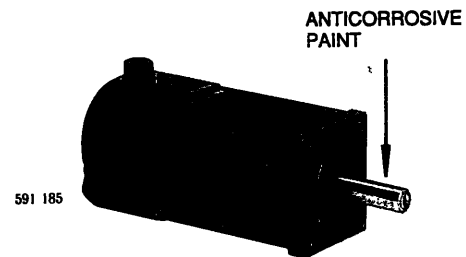

Fig 9.1 Anticorrosive Paint to be Removed

(2) Location

Use the motor under the following conditions:

- Indoors
- Free from corrosive and/or explosive gases or liquids
- Ambient temperature 0 to +40°C
- Accessible for inspection, maintenance and cleaning

If the AC SERVOMOTOR is subject to excessive water or oil droplets, protect the motor with a cover.

(3) Environmental Conditions

- Ambient Temperature 0 to +40°C
- Storage Temperature -20 to +60°C
- Humidity 20 to 80%RH (non-condensing)

(4) Load Coupling

True alignment of motor and driven machine is essential to prevent vibration, reduced bearing and coupling life, or shaft and bearing failures

Use flexible couplings for direct drives Alignment should be made in accordance with Fig 9 2

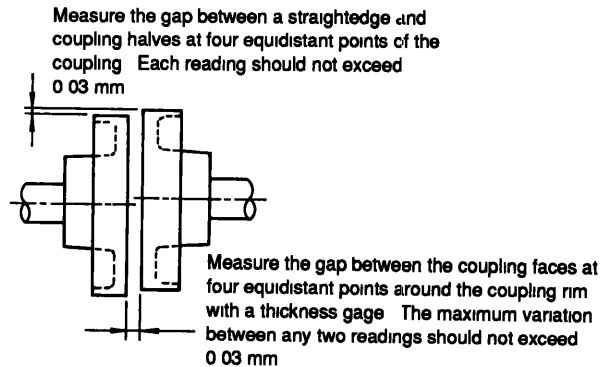

Fig 9 2 Alignment of Coupling

(5) Allowable Bearing Load

Avoid shock to the motor shaft when mounting gear box, coupling or pulley (50 G or less). If unavoidable, don't exceed thrust and radial loads specified in Table 4 1

9.2.2 SGD SERVOPACK

(1) Installation

SGD SERVOPACK (type SGD-□□□□) is a base-mounted type

(2) Location

- When installed in a panel
Keep the ambient temperature around SGD SERVOPACK at 55°C or below.
- When installed near a heat source
Keep the ambient temperature around SGD SERVOPACK below 55°C
- If subjected to vibration :
Mount the unit on shock absorbing material
- If corrosive gases are present ·
Avoid locations where corrosive gases exist since it may cause extensive damage over long use. Contactors and relays are especially vulnerable

(3) Mounting Direction

Mount the unit vertically on the wall using the mounting holes on the base plate, with main terminals at the bottom (Fig 9 3)

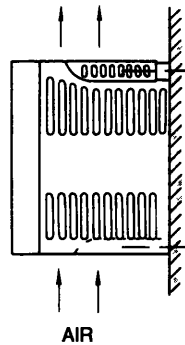

Fig 9 3 Mounting of SGD SERVOPACK

• Location

Ambient Temperature	0 to 55°C (above freezing)
Humidity	90% RH (non-condensing)
Vibration	0.5G (4.9 m/s ²) or below

• Precautions for mounting

- (1) Mount the unit vertically on a wall using the mounting holes on the base plate, with main terminals at the bottom
- (2) Make sure to mount the unit keeping enough surrounding space since cooling method of SERVOPACK is free convection type
- (3) If SERVOPACKS are mounted side by side, temperature may rise somewhat because of the uneven temperature inside the panels. Therefore, provide a fan/fans above the SERVOPACK blowing down on the units.

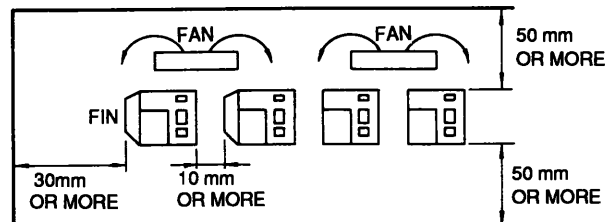

9.3 WIRING

9.3.1 Rated Current and Cable Size

Tables 9 1 and 9 2 show external terminals, rated current, and cable sizes of the power unit and SERVOPACK, respectively. Select the type and size of cables to meet ambient conditions and current capacity. The cable size is calculated so that a bundle of three cables can carry the rated current at an ambient temperature of 40°C. Table 9 3 lists the type of cables.

Table 9 1 Rated Current

External Terminal		Symbol	Rated Current A (rms) (Effective Current)									
			200 V AC						100 V AC			
			SGD-A3AS	SGD-A5AS	SGD-01AS	SGD-02AS	SGD-04AS	SGD-08AS	SGD-A3BS	SGD-A5BS	SGD-01BS	SGD-02BS
On Line	Main Circuit Power Input	Ⓡ Ⓣ	1.3	1.5	2.5	4.0	6.0	11.0	2.0	2.6	4.5	8.0
	Motor Connection	Ⓤ Ⓥ Ⓦ	0.42	0.6	0.87	2.0	2.6	5.5	0.63	0.7	2.2	2.7
Off Line	Control I/O Signal Connector	1CN	100 mA DC max									
	PG Signal Connector	2CN	100 mA DC max (500 mA for power line only)									
	Ground		—									

9.3.1 Rated Current and Cable Size (Cont'd)

Table 9 2 Recommended Cable Size of SERVOPACK

External Terminal		Symbol	Cable Size mm ²								
			200 V AC				100 V AC				
			SGD-A3AS	SGD-A5AS	SGD-01AS	SGD-02AS	SGD-04AS	SGD-08AS	SGD-A3BS	SGD-A5BS	SGD-01BS
On Line	Main Circuit Power Input	Ⓡ Ⓣ	HIV 1 25 or more				HIV 2 0		HIV 1 25 or more		HIV 2 0 or more
	Motor Connection	Ⓢ Ⓥ Ⓦ 	Use cables provided by YASKAWA For details, see Par 10 5, "CABLES " If other cables are used, confirm your rated current and select a twisted cable within a range of AWG22 toAWG18 (0 3 to 0 89 mm ²)								
Off Line	Control I/O Signal Connector	1CN	Cable	Two-core twisted shielded cable							
			Applicable Cable	AWG 24, 28, 30							
			Finished Cable Dimension	φ 16 0 mm max							
	PG Signal Connector	2CN	Cable	Use cables provided by YASKAWA For details, see Par 10 5, "CABLES " If other cables are used, use a two-core twisted shielded cable							
			Applicable Cable	AWG 24, 26, 28, 30 For power supply (for encoder) and FG line, apply AWG 22 (0 32 mm ²) For other signals, apply AWG 26 (0 12 mm ²) By connecting above, cables, wiring distance can be extended to 20 m							
			Finished Cable Dimension	φ 11 6 mm max							

Table 9 3 Cable

Type of Lead	Allowable Conductor Temperature (°C)
Vinyl Cable (PVC)	—
600 V Vinyl Cable (IV)	60
Special Heat-Resistant Cable (HIV)	75

Notes

- 1 For main circuits, use cables of 600 V or more
- 2 Where cables are bundled or run in a duct (unplasticized polyvinyl chloride conduit or metallic conduit), select a cable size larger than listed considering the current drop rate of the cables
- 3 Where the ambient (panel interior) temperature is high (40°C to 60°C), use heat-resistant cables

9.3.2 Wiring Precautions

SERVOPACK is a device for speed control of 5000 · 1, and signal level of several milli-volts or less. The following precautions should be taken when wiring.

- (1) For signal lines and PG feedback lines, use twisted cables or multi-core shielded twisted-pair cables (Yaskawa Drawing No. B9400064 or DE8400093). Cable length is a maximum of 3 m for reference input lines and a maximum of 20 m for PG feedback lines. Use the shortest possible length.
- (2) For ground line, cable should be as heavy as possible to provide Class 3 ground (ground resistance 100Ω or less). Use central grounding point. If the motor and machine are insulated, ground the motor.
- (3) To prevent malfunction due to noise, take the following precautions:
 - Place noise filters, SGD SERVOPACK and I/O reference as near as possible to each other.
 - Make sure to insert a surge suppressing circuit into the relay, electromagnetic contact, and solenoid coils.
 - Run the power line and signal line, keeping the distance to 30 cm or more, do not run them in the same duct or in a bundle.
 - When the same power is used for SERVOPACK as for an electric welder or electrical discharge machine or when a high-frequency noise source is present in the vicinity, use filters in the power and input circuits.
 - The SERVOPACK uses a switching amplifier, and electrical noise may be present in the signal line.
- (4) Remedy for Radio Frequency Interference (R F I)
SGD SERVOPACK may interfere with radio reception. If the controller interferes with radio reception, connect a noise filter to the power supply.
- (5) The signal line uses cables whose cores are extremely fine (0.2 to 0.3 mm²). Avoid using excessive force which may damage these cables.

9.3.3 Power Consumption

The following shows the power consumption of SERVOPACK.

Table 9.4 Power Consumption at Rated Output

SERVOPACK Type	Supply Voltage	Capacity W	Output Current A (rms)	Power Loss W
SGD-A3AS	200 V AC	30	0.42	15
SGD-A5AS		50	0.60	18
SGD-01AS		100	0.87	20
SGD-02AS		200	2.0	35
SGD-04AS		400	2.6	45
SGD-08AS		800	4.4	60
SGD-A3BS	100 V AC	30	0.63	17
SGD-A5BS		50	0.90	20
SGD-01BS		100	2.2	30
SGD-02BS		200	2.7	47

10. OUTSIDE DIMENSIONS in mm (inches)

10.1 SGM SERVOMOTOR

(1) With Incremental Encoder, without Brake

·30 W (0 04 HP), 50 W (0 07 HP), 100 W (0 13 HP)

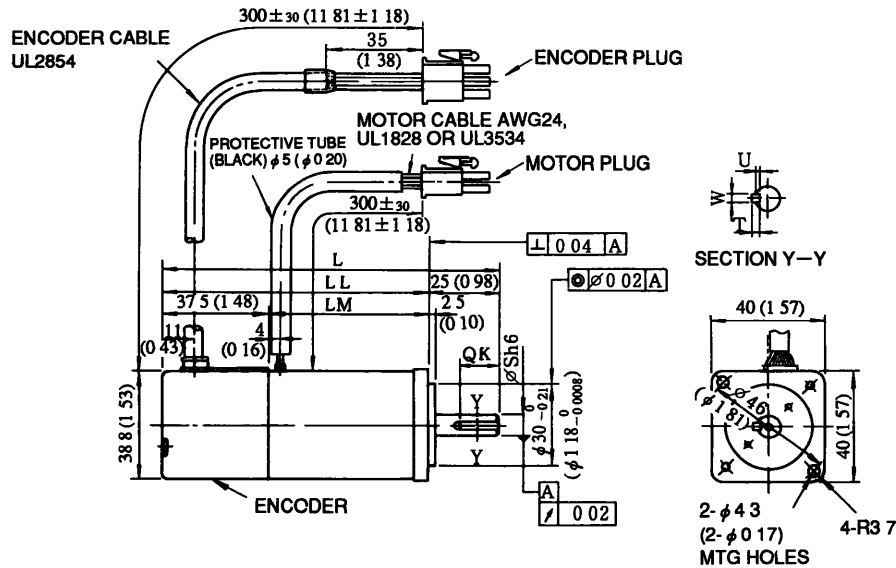

Type SGM-	L	LL	LM	S	QK	U	W	T	Output W (HP)	Mass g (lb)	Allowable Radial load N (lb)	Allowable Thrust Load N (lb)
A3A312	94 5 (3 72)	69 5 (2 74)	32 0 (1 26)	6 (0 24)	Without key				30 (0 04)	300 (0 66)	49 (11)	19 (4)
A3B312					14	1 2	2	2				
A3A314					(0 55)	(0 05)	(0 08)	(0 08)				
A3B314												
A5A312	102 0 (4 02)	77 0 (3 03)	39 5 (1 56)	6 (0 24)	Without key				50 (0 07)	400 (0 88)	68 (15)	19 (4)
A5B312					14	1 2	2	2				
A5A314					(0 55)	(0 05)	(0 08)	(0 08)				
A5B314												
01A312	119 5 (4 70)	94 5 (3 72)	57 0 (2 24)	8 (0 31)	Without key				100 (0 13)	500 (1 10)	68 (15)	19 (4)
01B312					14	1 8	3	3				
01A314					(0 55)	(0 07)	(0 12)	(0 12)				
01B314												

Notes

- 1 Detector uses incremental encoder 2048 P/R
- 2 As for type designation, "A" shows that SERVOMOTOR applies 200 VAC power and "B" shows that SERVOMOTOR applies 100 VAC power

Connector specifications

Ⓐ Motor plug

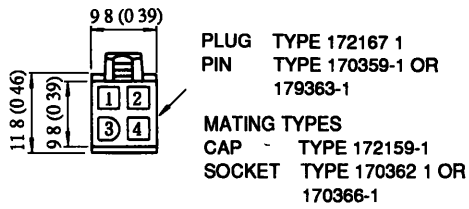

• Motor connection

1	Phase-U	Red
2	Phase-V	White
3	Phase-W	Blue
4	FG (Frame ground)	Green

Ⓑ Encoder plug

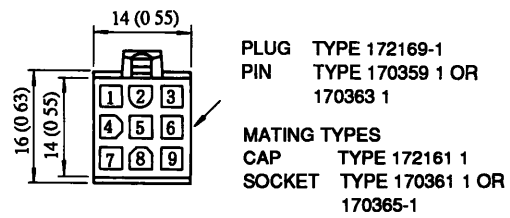

• Incremental encoder connection

1	Channel A output	Blue
2	Channel A output	Blue/Black
3	Channel B output	Yellow
4	Channel B output	Yellow/Black
5	Channel C output	Green
6	Channel C output	Green/Black
7	0V (Power supply)	Gray
8	+5 (Power supply)	Red
9	FG (Frame ground)	Orange

Manufacturer of connector : Amp

· 200 W (0 27 HP), 400 W (0 53 HP)

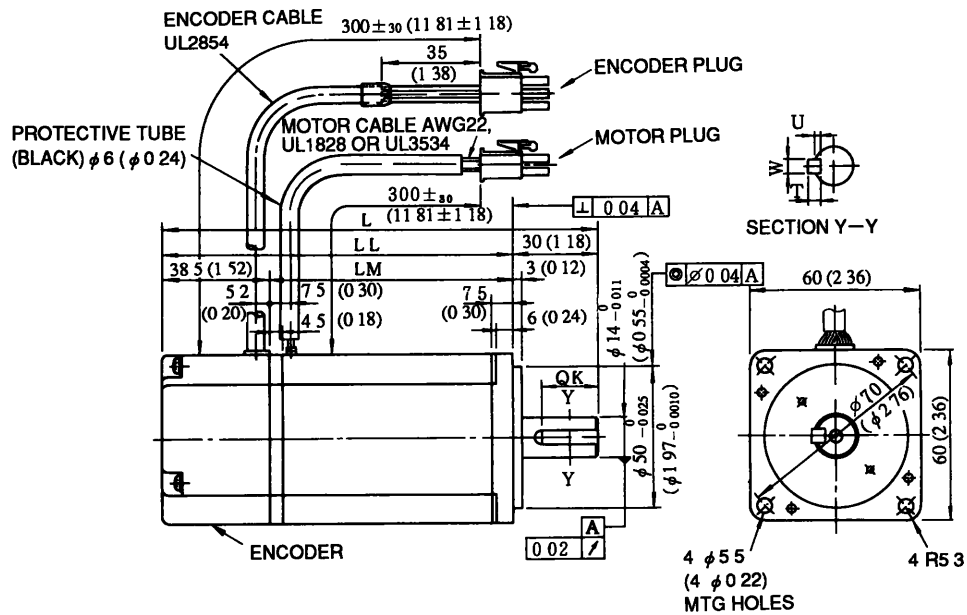

Type SGM-	L	LL	LM	OK	U	W	T	Output W (HP)	Mass g (lb)	Allowable Radial Load N (lb)	Allowable Thrust Load N (lb)
02A312	126 5 (4 98)	96 5 (3 80)	58 0 (2 28)	Without key				200 (0 27)	1100 (2 43)	196 (44)	49 (11)
02B312				20	3	5	5				
02A314				(0 79)	(0 12)	(0 20)	(0 20)				
02B314											
04A312	154 5 (6 08)	124 5 (4 90)	86 0 (3 39)	Without key				400 (0 53)	1700 (3 75)	196 (44)	68 (15)
04A314				20	3	5	5				
				(0 79)	(0 12)	(0 20)	(0 20)				

Notes

- 1 Detector uses incremental encoder 2048 P/R
- 2 As for type designation, "A" shows that SERVOMOTOR applies 200 VAC power and "B" shows that SERVOMOTOR applies 100 VAC power

Connector specifications

Ⓐ Motor plug

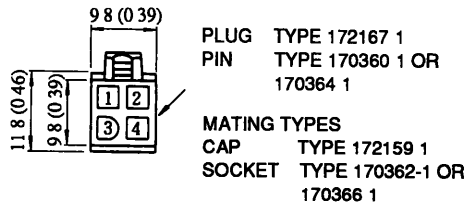

• Motor connection

1	Phase-U	Red
2	Phase-V	White
3	Phase-W	Blue
4	FG (Frame ground)	Green

Ⓑ Encoder plug

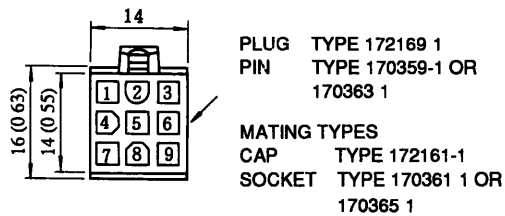

• Incremental encoder connection

1	Channel A output	Blue
2	Channel \bar{A} output	Blue/Black
3	Channel B output	Yellow
4	Channel \bar{B} output	Yellow/Black
5	Channel C output	Green
6	Channel \bar{C} output	Green/Black
7	0V (Power supply)	Gray
8	+5V (Power supply)	Red
9	FG (Frame ground)	Orange

Manufacturer of connector Amp

· 750 W (1 01 HP)

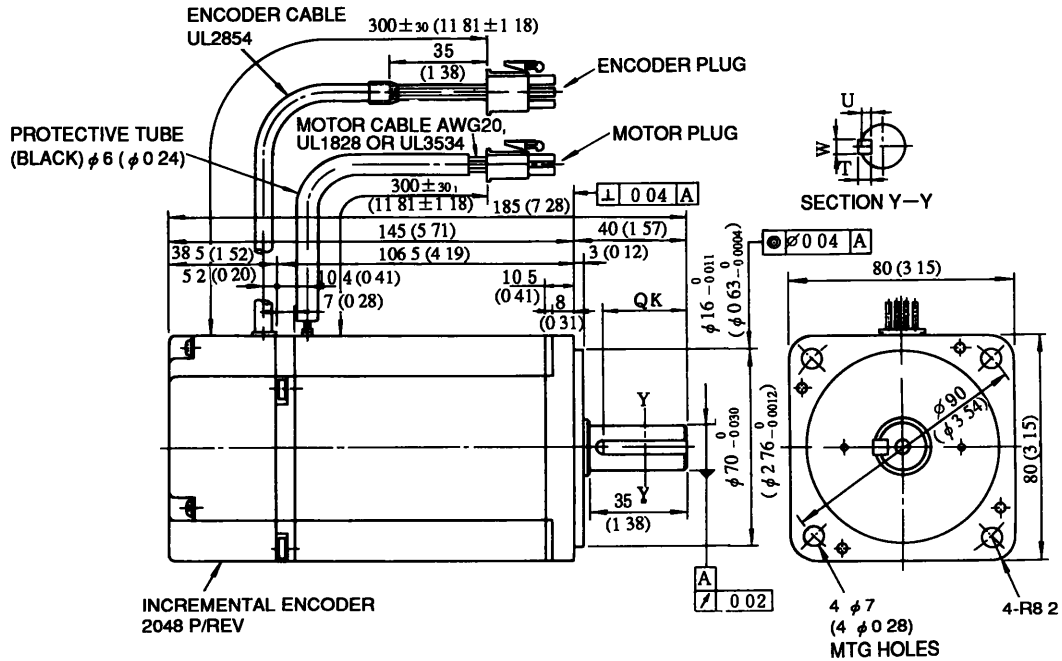

Type SGM-	QK	U	W	T	Output W (HP)	Mass g (lb)	Allowable Radial Load N (lb)	Allowable Thrust Load N (lb)
08A312	Without key				750 (1 01)	3400 (7 50)	343 (77)	98 (22)
08A314	30 (1 18)	3 (0 12)	5 (0 20)	5 (0 20)				

Notes

- 1 Detector uses incremental encoder 2048 P/R
- 2 As for type designation, "A" shows that SERVOPACK applies 200 VAC power

Connector specifications

Ⓐ Motor plug

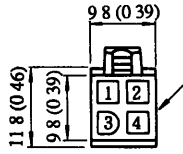

PLUG TYPE 172167-1
 PIN TYPE 170360-1 OR
 179364 1

MATING TYPES
 CAP TYPE 172159 1
 SOCKET TYPE 170362-1 OR
 170366 1

• Motor connection

1	Phase-U	Red
2	Phase-V	White
3	Phase-W	Blue
4	FG (Frame ground)	Green

Ⓑ Encoder plug

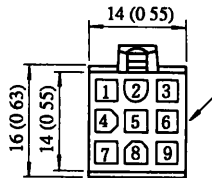

PLUG TYPE 172169-1
 PIN TYPE 170359 1 OR
 170363-1

MATING TYPES
 CAP TYPE 172161 1
 SOCKET TYPE 170361-1 OR
 170365 1

• Incremental encoder connection

1	Channel A output	Blue
2	Channel \bar{A} output	Blue/Black
3	Channel B output	Yellow
4	Channel \bar{B} output	Yellow/Black
5	Channel C output	Green
6	Channel \bar{C} output	Green/Black
7	0 V (Power supply)	Gray
8	+5 V (Power supply)	Red
9	FG (Frame ground)	Orange

Manufacturer of connector Amp

(2) With Incremental Encoder, with Brake

·30 W (0 04 HP), 50 W (0 07HP), 100 W (0 13 HP)

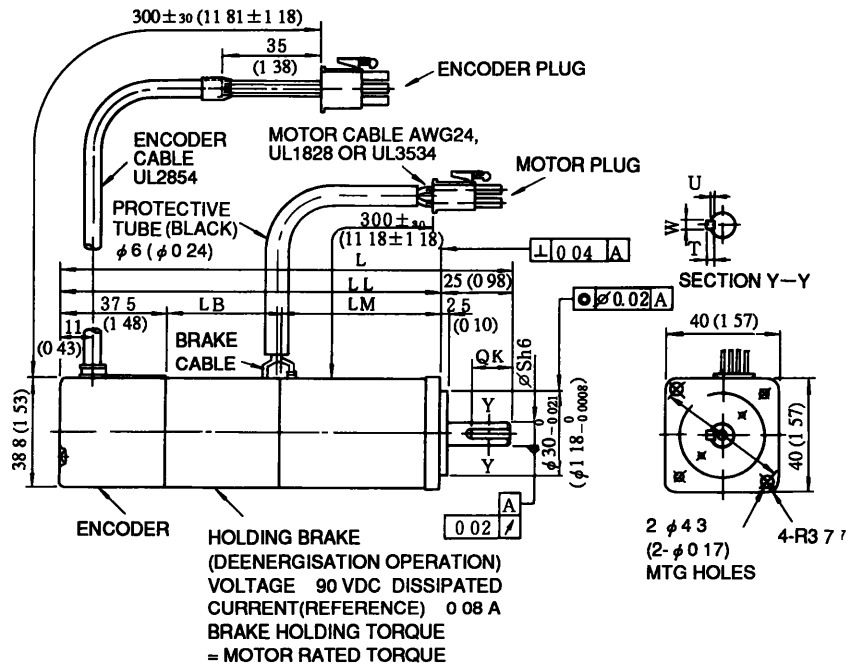

Type SGM-	L	LL	LM	LB	S	OK	U	W	T	Output W (HP)	Mass g (lb)	Allowable Radial Load N (lb)	Allowable Thrust Load N (lb)
A3A312B	126 0 (4 96)	101 0 (3 98)	32 0 (1 26)	31 5 (1 24)	6 (0 24)	Without key				30 (0 04)	600 (1 32)	49 (11)	19 (4)
A3B312B						14 (0 55)	1 2 (0 05)	2 (0 08)	2 (0 08)				
A3A314B													
A3B314B													
A5A312B	133 5 (5 26)	108 5 (4 27)	39 5 (1 56)	31 5 (1 24)	6 (0 24)	Without key				50 (0 07)	700 (1 54)	68 (15)	19 (4)
A5B312B						14 (0 55)	1 2 (0 05)	2 (0 08)	2 (0 08)				
A5A314B													
A5B314B													
01A312B	160 0 (6 30)	135 0 (5 31)	57 0 (2 24)	40 5 (1 59)	8 (0 31)	Without key				100 (0 13)	800 (1 76)	68 (15)	19 (4)
01B312B						14 (0 05)	1 8 (0 07)	3 (0 12)	3 (0 12)				
01A314B													
01B314B													

Notes

- 1 Detector uses incremental encoder 2048 P/R
- 2 As for type designation, "A" shows that SERVOMOTOR applies 200 VAC power and "B" shows that SERVOMOTOR applies 100 VAC power

Connector specifications

Ⓐ Motor plug

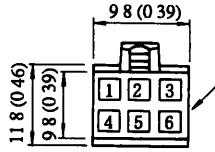

PLUG TYPE 172168-1
 PIN TYPE 170359-1 OR
 179363-1

MATING TYPES
 CAP TYPE 172160-1
 SOCKET TYPE 170362 1 OR
 170366-1

• Motor and brake connection

1	Phase-U	Red
2	Phase-V	White
3	Phase-W	Blue
4	FC (Frame ground)	Green
5	Brake terminal	Black
6	Brake terminal	Black

Ⓑ Encoder plug

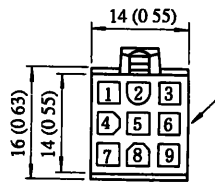

PLUG TYPE 172169-1
 PIN TYPE 170359-1 OR
 170363-1

MATING TYPES
 CAP TYPE 172161 1
 SOCKET TYPE 170361 1 OR
 170365 1

• Incremental encoder connection

1	Channel A output	Blue
2	Channel \bar{A} output	Blue/Black
3	Channel B output	Yellow
4	Channel \bar{B} output	Yellow/Black
5	Channel C output	Green
6	Channel \bar{C} output	Green/Black
7	0V (Power supply)	Gray
8	+5V (Power supply)	Red
9	FG (Frame ground)	Orange

Manufacturer of connector Amp

200 W (0 27 HP), 400 W (0 53HP)

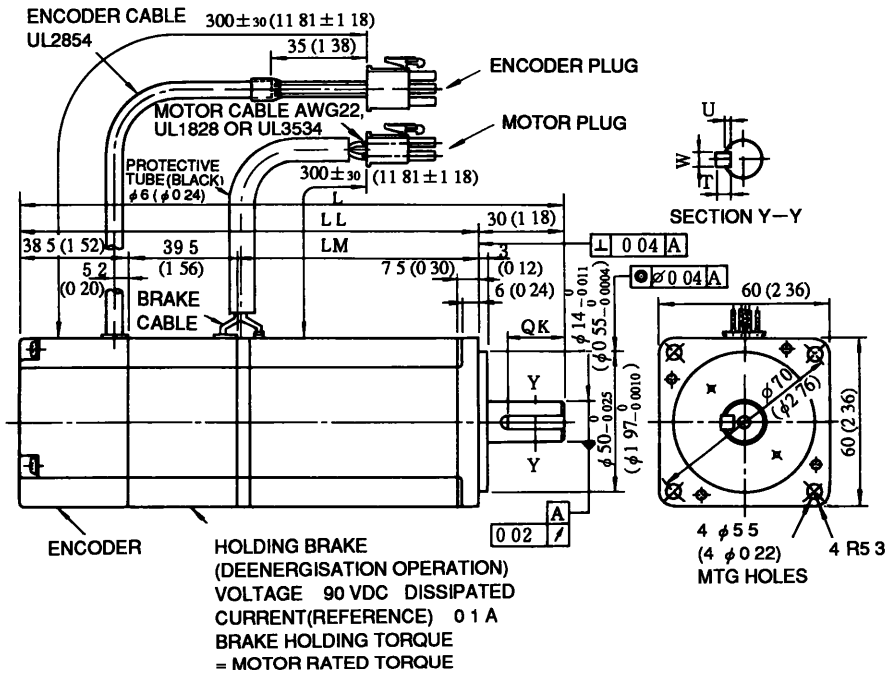

Type SGM-	L	LL	LM	QK	U	W	T	Output W (HP)	Mass g (lb)	Allowable Radial Load N (lb)	Allowable Thrust Load N (lb)
02A312B	166 0 (6 54)	136 0 (5 35)	58 0 (2 28)	Without key				200 (0 27)	1600 (3 53)	196 (44)	49 (11)
02B312B				20 (0 79)	3 (0 12)	5 (0 20)	5 (0 20)				
02A314B				Without key							
02B314B				20 (0 79)	3 (0 12)	5 (0 20)	5 (0 20)				
04A312B	194 0 (7 64)	164 0 (6 46)	86 0 (3 39)	Without key				400 (0 53)	2200 (4 85)	196 (44)	68 (15)
04B312B				20 (0 79)	3 (0 12)	5 (0 20)	5 (0 20)				
04A314B				Without key							
04B314B				20 (0 79)	3 (0 12)	5 (0 20)	5 (0 20)				

Notes

- 1 Detector uses incremental encoder 2048 P/R
- 2 As for type designation, 'A' shows that SERVOMOTOR applies 200 VAC power and "B" shows that SERVOMOTOR applies 100 VAC power

Connector specifications

Ⓐ Motor plug

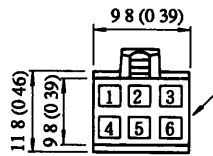

PLUG TYPE 172168-1(AMP)
 PIN TYPE 170360 1 OR
 170364 1

MATING TYPES
 CAP TYPE 172160 1
 SOCKET TYPE 170362-1 OR
 170366 1

• Motor and brake connection

1	Phase-U	Red
2	Phase-V	White
3	Phase-W	Blue
4	FG (Frame ground)	Green
5	Brake terminal	Black
6	Brake terminal	Black

Ⓑ Encoder plug

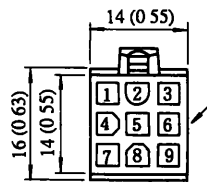

PLUG TYPE 172169-1(AMP)
 PIN TYPE 170359 1 OR
 170363 1

MATING TYPES
 CAP TYPE 172161 1
 SOCKET TYPE 170361 1 OR
 170365-1

• Incremental encoder connection

1	Channel A output	Blue
2	Channel \bar{A} output	Blue/Black
3	Channel B output	Yellow
4	Channel \bar{B} output	Yellow/Black
5	Channel C output	Green
6	Channle \bar{C} output	Green/Black
7	0V (Power supply)	Gray
8	+5V (Power supply)	Red
9	FG (Frame ground)	Orange

Manufacturer of connector Amp

· 750 W (1 01 HP)

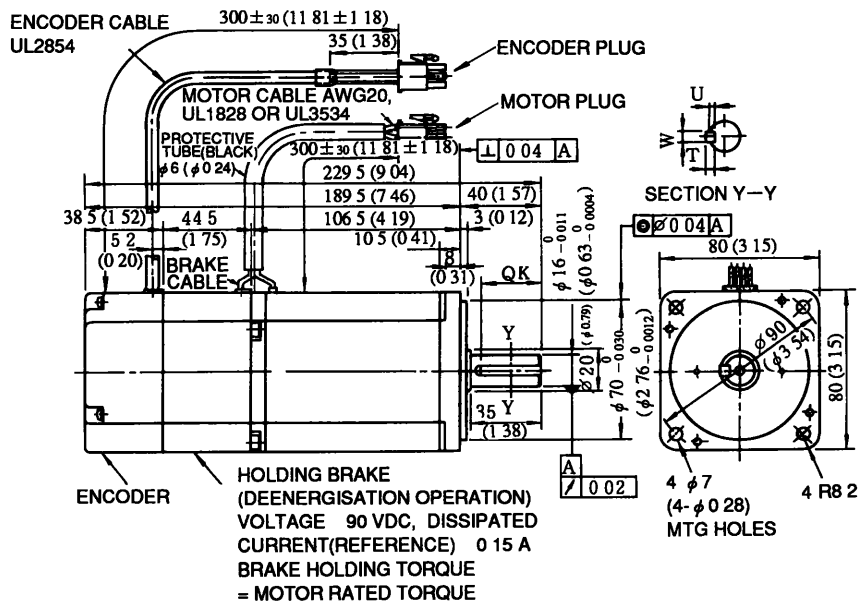

Type SMG-	QK	U	W	T	Output W (HP)	Mass g (lb)	Allowable Radial Load (lb)	Allowable Thrust Load N (lb)
08A312B	Without Key				750 (1 01)	4300 (9 48)	343 (77)	98 (22)
08A314B	30 (1 18)	3 (0 12)	5 (0 20)	5 (0 20)				

Notes

- 1 Detector uses incremental encoder 2048 P/R
- 2 As for type designation, "A" shows that SERVOMOTOR applies 200 VAC power

Connector specifications

Ⓐ Motor plug

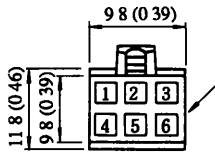

PLUG TYPE 172168-1
 PIN TYPE 170360 1 OR
 170364 1

MATING TYPES
 CAP TYPE 172160 1
 SOCKET TYPE 170362-1 OR
 170366 1

• Motor and brake connection

1	Phase-U	Red
2	Phase-V	White
3	Phase-W	Blue
4	FG (Frame ground)	Green
5	Brake terminal	Black
6	Brake terminal	Black

Ⓑ Encoder plug

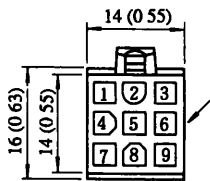

PLUG TYPE 172169-1
 PIN TYPE 170359 1 OR
 170363-1

MATING TYPES
 CAP TYPE 172161 1
 SOCKET TYPE 170361-1 OR
 170365 1

• Incremental encoder connection

1	Channel A output	Blue
2	Channel A output	Blue/Black
3	Channel B output	Yellow
4	Channel B output	Yellow/Black
5	Channel C output	Green
6	Channel C output	Green/Black
7	0V (Power supply)	Gray
8	+5V (Power supply)	Red
9	FG (Frame ground)	Orange

Manufacturer connector Amp

(3) With Absolute Encoder, without Brake

· 30 W (0 04 HP), 50 W (0 07HP), 100 W (0 13 HP)

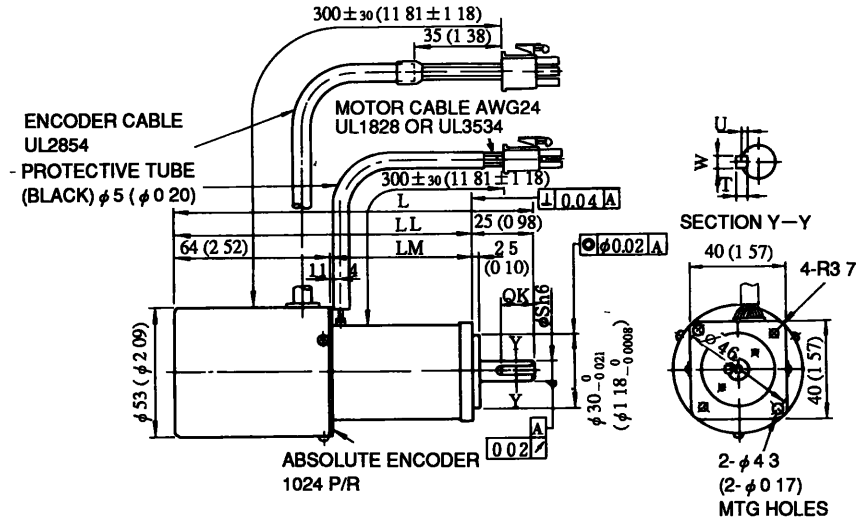

Type SGM-	L	LL	LM	S	QK	U	W	T	Output W (HP)	Mass g (lb)	Allowable Radial Load N (lb)	Allowable Thrust Load N (lb)
A3AW12	121 0 (4 76)	96 0 (3 78)	32 0 (1 26)	6 (0 24)	Without key				30 (0 04)	450 (0 99)	49 (11)	19 (4)
A3BW12					14	1 2	2	2				
A3AW14	128 5 (5 06)	103 5 (4 07)	39 5 (1 56)	6 (0 24)	Without key				50 (0 07)	550 (1 21)	68 (15)	19 (4)
A3BW14					14	1 2	2	2				
A5AW12	146 0 (5 75)	121 0 (4 76)	57 0 (2 24)	8 (0 31)	Without key				100 (0 13)	650 (1 43)	68 (15)	19 (4)
A5BW12					14	1 8	3	3				
A5AW14	146 0 (5 75)	121 0 (4 76)	57 0 (2 24)	8 (0 31)	Without key				100 (0 13)	650 (1 43)	68 (15)	19 (4)
A5BW14					14	1 8	3	3				
01AW12	146 0 (5 75)	121 0 (4 76)	57 0 (2 24)	8 (0 31)	Without key				100 (0 13)	650 (1 43)	68 (15)	19 (4)
01BW12					14	1 8	3	3				
01AW14	146 0 (5 75)	121 0 (4 76)	57 0 (2 24)	8 (0 31)	Without key				100 (0 13)	650 (1 43)	68 (15)	19 (4)
01BW14					14	1 8	3	3				

Notes

1 Detector uses 12-bit absolute encoder 1048 P/R

2 As for type designation, "A" shows that SERVOMOTOR applies 200 V AC power and "B" shows that SERVOMOTOR applies 100 V AC power

Connector specifications

Ⓐ Motor plug



PLUG TYPE 172167-1
 PIN TYPE 170359-1 OR
 170363 1

MATING TYPES
 CAP TYPE 172159 1
 SOCKET TYPE 170362-1 OR
 170366-1

• Motor connection

1	Phase-U	Red
2	Phase-V	White
3	Phase-W	Blue
4	FG (Frame ground)	Green

Ⓑ Encoder plug

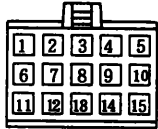

PLUG TYPE 172171-1
 PIN TYPE 170359-1 OR
 170363 1

MATING TYPES
 CAP TYPE 172163 1
 SOCKET TYPE 170361 1 OR
 170365-1

• Absolute encoder connection

1	Channel A output	Blue
2	Channel \bar{A} output	White/Blue
3	Channel B output	Yellow
4	Channel \bar{B} output	White/Yellow
5	Channel Z output	Green
6	Channel \bar{Z} output	White/Green
7	0V (Power supply)	Black
8	+5V (Power supply)	Red
9	FG (Frame ground)	Green/Yellow
10	Channel S output	Purple
11	Channel \bar{S} output	White/Purple
* (12)	(Capacitor reset)	(Gray)
13	Reset	White/Gray
14	0V (Battery)	White/Orange
15	3.6V (Battery)	Orange

Manufacturer of connectors Amp

* Don't use this terminal since this is used for capacitor discharge terminal at shipment

· 200 W (0 27 HP), 400 W (0 53 HP)

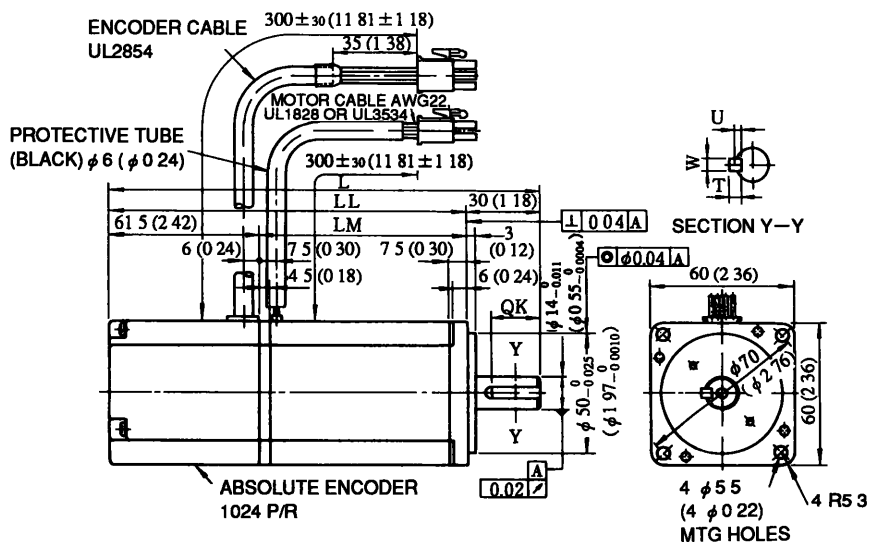

Type SGM-	L	LL	LM	QK	U	W	T	Output W (HP)	Mass g (lb)	Allowable Radial Load N (lb)	Allowable Thrust Load N (lb)
02AW12	149 5 (5 89)	119 5 (4 70)	58 0 (2 28)	Without key				200 (7 87)	1200 (2 65)	196 (44)	49 (11)
02BW12				20 (0 79)	3 (0 12)	5 (0 20)	5 (0 20)				
02AW14	177 5 (6 99)	147 5 (5 81)	86 0 (3 39)	Without key				400 (15 7)	1800 (3 97)	196 (44)	68 (15)
04AW14				20 (0 79)	3 (0 12)	5 (0 20)	5 (0 20)				

Notes

- 1 Detector uses 12-bit absolute encoder 1048 P/R
- 2 As for type designation, "A" shows that SERVOMOTOR applies 200 VAC power and "B" shows that SERVOMOTOR applies 100 VAC power

Connector specifications

Ⓐ Motor plug

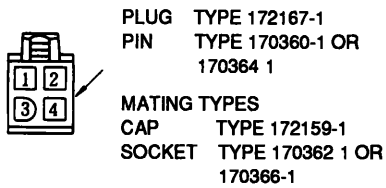

• Motor connection

1	Phase-U	Red
2	Phase-V	White
3	Phase-W	Blue
4	FG (Frame ground)	Green

Ⓑ Encoder plug

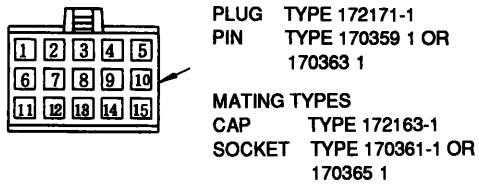

• Absolute encoder connection

1	Channel A output	Blue
2	Channel \bar{A} output	White/Blue
3	Channel B output	Yellow
4	Channel \bar{B} output	White/Yellow
5	Channel Z output	Green
6	Channel \bar{Z} output	White/Green
7	0V (Power supply)	Black
8	+5V (Power supply)	Red
9	FG (Frame ground)	Green/Yellow
10	Channel S output	Purple
11	Channel \bar{S} output	White/Purple
* (12)	(Capacitor reset)	(Gray)
13	Reset	White/Gray
14	0V (Battery)	White/Orange
15	3.6V (Battery)	Orange

Manufacturer of connector Amp

* Don't use this terminal since this is used for capacitor discharge terminal at shipment

· 750 W (1 01 HP)

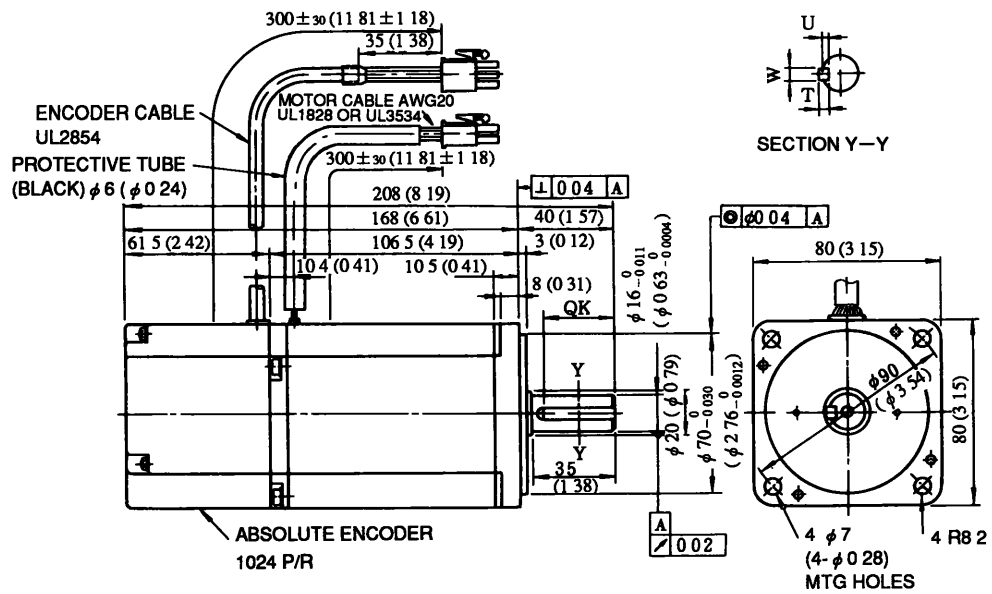

Type SGM-	QK	U	W	T	Output W (HP)	Moss g (lb)	Allowable Radial Load N (lb)	Allowable Thrust Load N (lb)
08AW12	Without key				750 (1 01)	3500 (7 72)	343 (77)	98 (22)
08AW14	30 (1 18)	3 (0 12)	5 (0 20)	5 (0 20)				

Notes

- 1 Detector uses 12-bit absolute encoder 1024 P/R
- 2 As for type designation, "A" shows that SERVOMOTOR applies 200 VAC power

Connector specifications

Ⓐ Motor plug

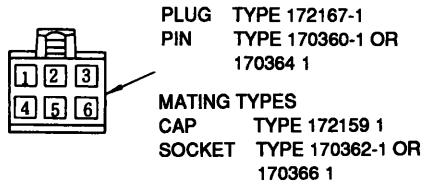

• Motor connection

1	Phase-U	Red
2	Phase-V	White
3	Phase-W	Blue
4	FG (Frame ground)	Green

Ⓑ Encoder plug

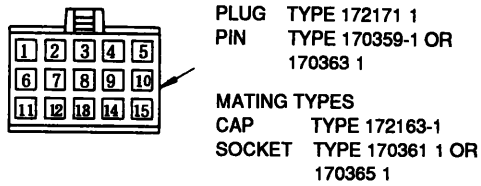

• Absolute encoder connection

1	Channel A output	Blue
2	Channel \bar{A} output	White/Blue
3	Channel B output	Yellow
4	Channel \bar{B} output	White/Yellow
5	Channel Z output	Green
6	Channel \bar{Z} output	White/Green
7	0V (Power supply)	Black
8	+5V (Power supply)	Red
9	FG (Frame ground)	Green/Yellow
10	Channel S output	Purple
11	Channel \bar{S} output	White/Purple
* (12)	(Capacitor reset)	(Gray)
13	Reset	White/Gray
14	0V (Battery)	White/Orange
15	3.6V (Battery)	Orange

Manufacturer of connector : Amp

* Don't use this terminal since this is used for capacitor discharge terminal at shipment

(4) With Absolute Encoder, With Brake

· 30 W (0 04 HP), 50 W (0 07HP), 100 W (0 13 HP)

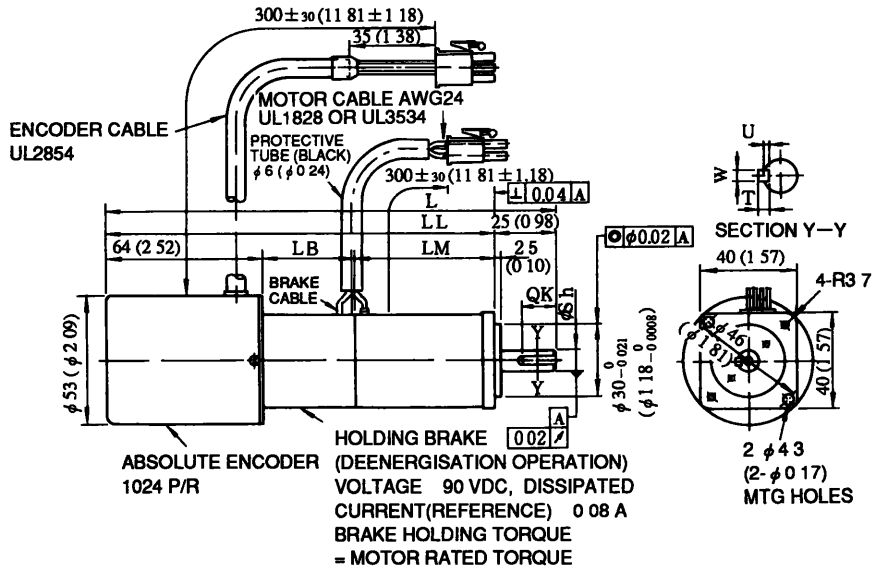

Type SGM-	L	LL	LM	LB	QK	U	W	T	S	Output W (HP)	Mass g (lb)	Allowable Radial Load N (lb)	Allowable Thrust Load N (lb)
A3AW12B					Without key								
A3BW12B	149 5	124 5	32 0	28 5					6	30	750	49 (11)	19 (4)
A3AW14B	(5 86)	(4 90)	(1 26)	(1 12)	14	1 2	2	2	(0 24)	(0 04)	(1 65)		
A3BW14B					(0 55)	(0 05)	(0 08)	(0 08)					
A5AW12B					Without key								
A5BW12B	157 0	132 0	39 5	28 5					6	50	850	68 (15)	19 (4)
A5AW14B	(6 18)	(5 20)	(1 56)	(1 12)	14	1 2	2	2	(0 24)	(0 07)	(1 87)		
A5BW14B					(0 55)	(0 05)	(0 08)	(0 08)					
01AW12B					Without key								
01BW12B	183 5	158 5	57 0	37 5					8	100	950	68 (15)	19 (4)
01AW14B	(7 22)	(6 24)	(2 24)	(1 48)	14	1 8	3	3	(0 31)	(0 13)	(2 09)		
01BW14B					(0 55)	(0 07)	(0 12)	(0 12)					

Notes

1 Detector uses 12-bit absolute encoder 2048 P/R

2 As for type designation 'A' shows that SERVOMOTOR applies 200 VAC power and 'B' shows that SERVOMOTOR applies 100 VAC power

Connector specifications

Ⓐ Motor plug

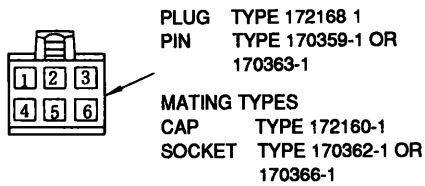

• Motor and brake connection

1	Phase-U	Red
2	Phase-V	White
3	Phase-W	Blue
4	FG (Frame ground)	Green
5	Brake terminal	Black
6	Brake terminal	Black

Ⓑ Encoder plug

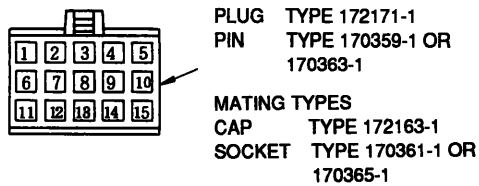

• Absolute encoder connection

1	Channel A output	Blue
2	Channel \bar{A} output	White/Blue
3	Channel B output	Yellow
4	Channel \bar{B} output	White/Yellow
5	Channel Z output	Green
6	Channel \bar{Z} output	White/Green
7	0V (Power supply)	Black
8	+5V (Power supply)	Red
9	FG (Frame ground)	Green/Yellow
10	Channel S output	Purple
11	Channel \bar{S} output	White/Purple
* (12)	(Capacitor reset)	(Gray)
13	Reset	White/Gray
14	0V (Battery)	White/Orange
15	3 6V (Battery)	Orange

Manufacturer of connector Amp

* Don't use this terminal since this is used for capacitor discharge terminal at shipment

· 200 W (0 27 HP), 400 W (0 53HP)

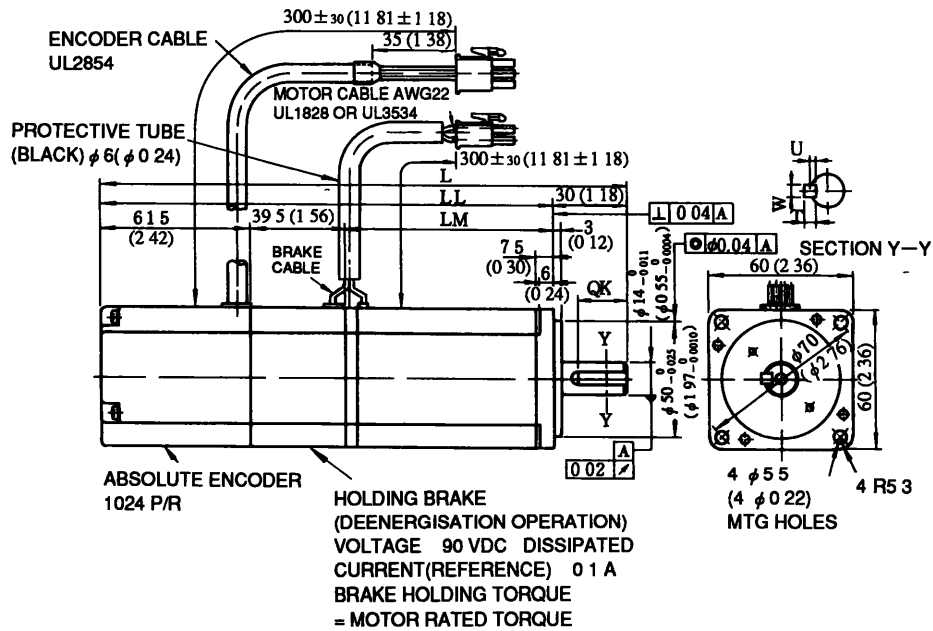

Type SGM-	L	LL	LM	OK	U	W	T	Output W (HP)	Mass g (lb)	Allowable Radial Load N (lb)	Allowable Thrust Load N (lb)
02AW12B	189 0 (7 44)	159 0 (6 26)	58 0 (2 28)	Without key				200 (7 87)	1700 (3 75)	196 (44)	49 (11)
02BW12B				20 (0 79)	3 (0 12)	5 (0 20)	5 (0 20)				
02AW14B				Without key							
02BW14B				20 (0 79)	3 (0 12)	5 (0 20)	5 (0 20)				
04AW12B	217 0 (8 54)	187 0 (7 36)	86 0 (3 39)	Without key				400 (15 7)	2300 (5 07)	196 (44)	68 (15)
04AW14B				20 (0 79)	3 (0 12)	5 (0 20)	5 (0 20)				

Notes

- 1 Detector uses 12-bit absolute encoder 1024 P/R
- 2 As for type designation, "A" shows that SERVOMOTOR applies 200 VAC power and "B" shows that SERVOMOTOR applies 100 VAC power

Connector specifications

Ⓐ Motor plug

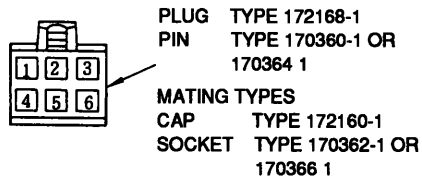

• Motor and brake connection

1	Phase-U	Red
2	Phase-V	White
3	Phase-W	Blue
4	FG (Frame ground)	Green
5	Brake terminal	Black
6	Brake terminal	Black

Ⓑ Encoder plug

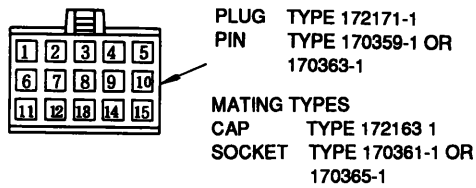

• Absolute encoder connection

1	Channel A output	Blue
2	Channel \bar{A} output	White/Blue
3	Channel B output	Yellow
4	Channel \bar{B} output	White/Yellow
5	Channel Z output	Green
6	Channel \bar{Z} output	White/Green
7	0V (Power supply)	Black
8	+5V (Power supply)	Red
9	FG (Frame ground)	Green/Yellow
10	Channel S output	Purple
11	Channel \bar{S} output	White/Purple
* (12)	(Capacitor reset)	(Gray)
13	Reset	White/Gray
14	0V (Battery)	White/Orange
15	3.6V (Battery)	Orange

Manufacturer of connector · Amp

* Don't use this terminal since this is used for capacitor discharge terminal at shipment

· 750 W (1 01 HP)

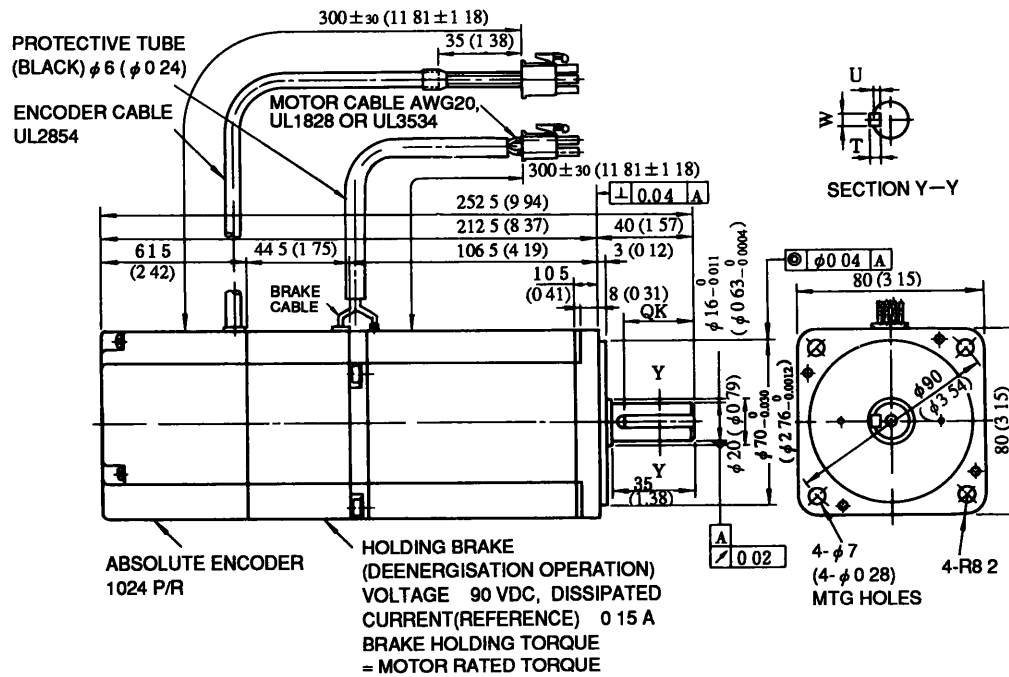

Type SGM-	QK	U	W	T	Output W (HP)	Mass g (lb)	Allowable Radial Load N (lb)	Allowable Thrust Load N (lb)
08AW12B	Without key				750 (1 01)	4500 (9 92)	343 (77)	98 (22)
08AW14B	30 (1 18)	3 (0 12)	5 (0 20)	5 (0 20)				

Notes

- 1 Detector uses 12-bit absolute encoder 1024 P/R
- 2 As for type designation "A" shows that SERVOMOTOR applies 200 VAC power

Connector specifications

Ⓐ Motor plug

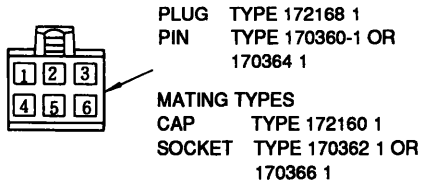

• Motor and brake connection

1	Phase-U	Red
2	Phase-V	White
3	Phase-W	Blue
4	FG (Frame ground)	Green
5	Brake terminal	Black
6	Brake terminal	Black

Ⓑ Encoder plug

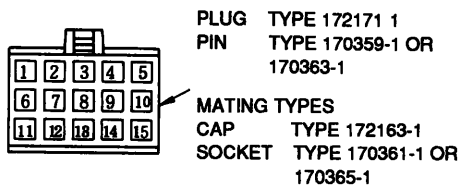

• Absolute encoder connection

1	Channel A output	Blue
2	Channel \bar{A} output	White/Blue
3	Channel B output	Yellow
4	Channel \bar{B} output	White/Yellow
5	Channel Z output	Green
6	Channel \bar{Z} output	White/Green
7	0V (Power supply)	Black
8	+5V (Power supply)	Red
9	FG (Frame ground)	Green/Yellow
10	Channel S output	Purple
11	Channel \bar{S} output	White/Purple
* (12)	(Capacitor reset)	(Gray)
13	Reset	White/Gray
14	0V (Battery)	White/Orange
15	3.6V (Battery)	Orange

* Don't use this terminal since this is used for capacitor discharge terminal at shipment

Manufacturer of connector Amp

10.2 SGD SERVOPACK

- Types SGD-A3A □ to 02 □ (200 V 30 (0.04 HP) to 200 W (0.27 HP))
 SGD-A3B □ to 01 □ (100 V 30 (0.04 HP) to 100 W (0.13 HP))

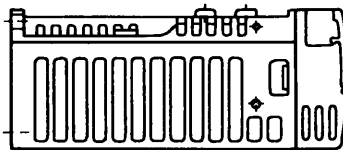
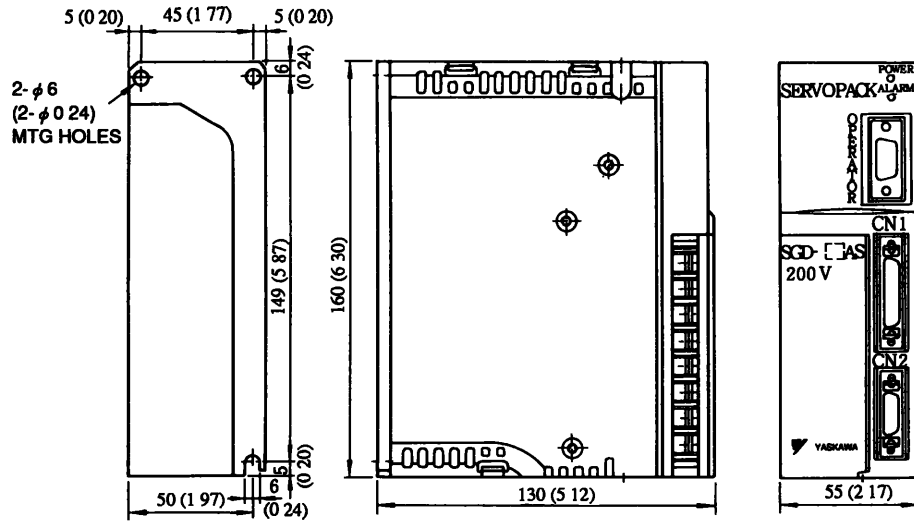

Approx Mass 0.9 kg (1.98 lb)

- Types SGD-04A □ (200 V 400 W (0.53 HP))
 SGD-02B □ (100 V 200 W (0.27 HP))

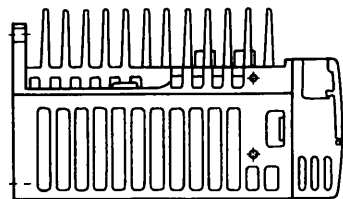
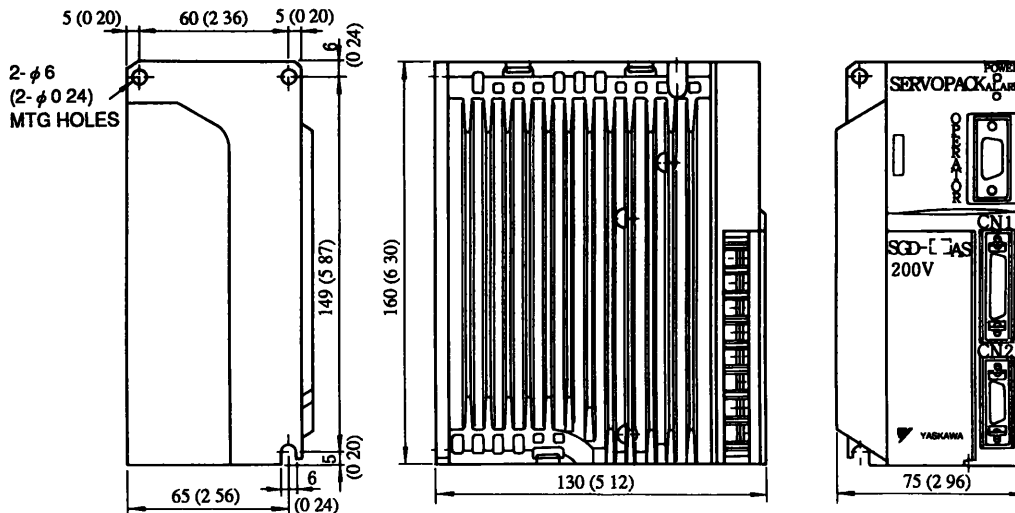

Approx Mass 1.2 kg (2.65 lb)

· Type SGD-08A □ (200 V 750 W (1 01 HP))

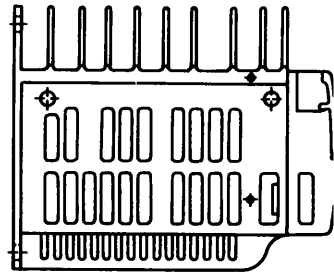
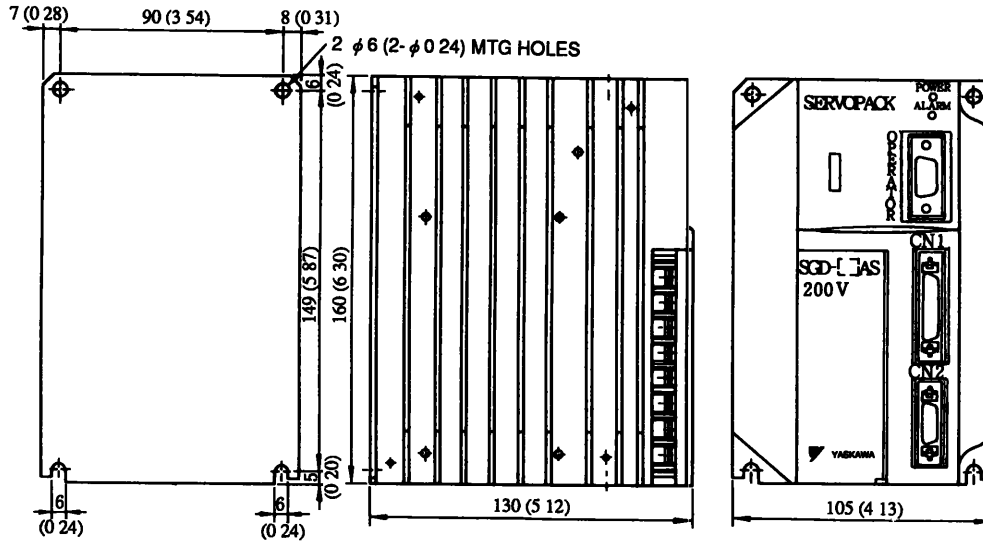

Approx Mass 1.5 kg (3.31 lb)

10.3 REGENERATIVE UNIT

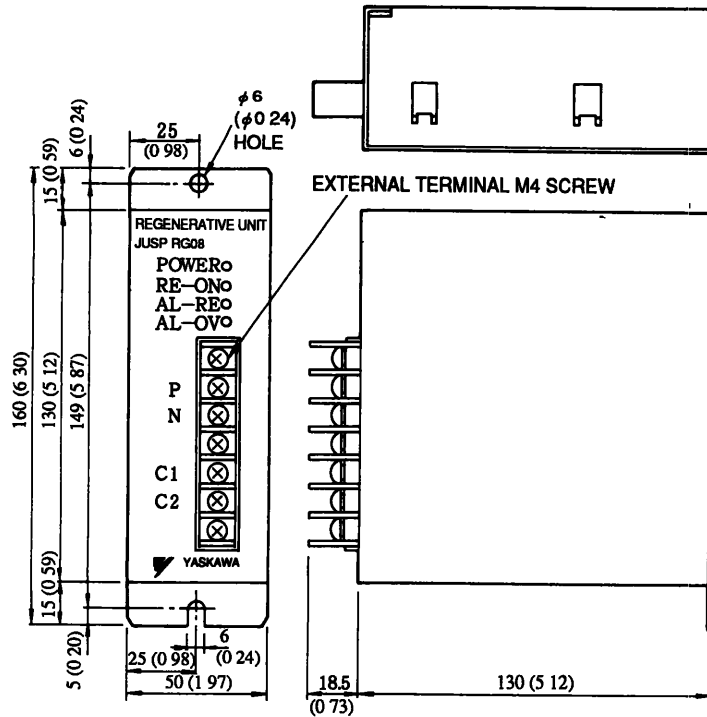

Approx Mass 1 kg (2.20 lb)

10.4 DIGITAL OPERATOR

• Type JUSP-OP02A-1

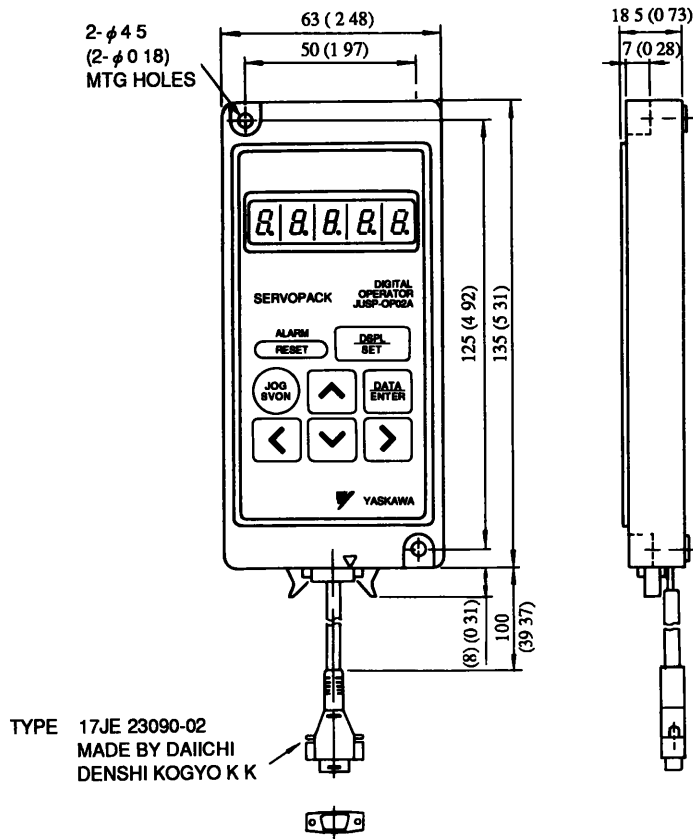

Approx Mass 0.18 kg (0.40 lb)

• Type JUSP-OP03A

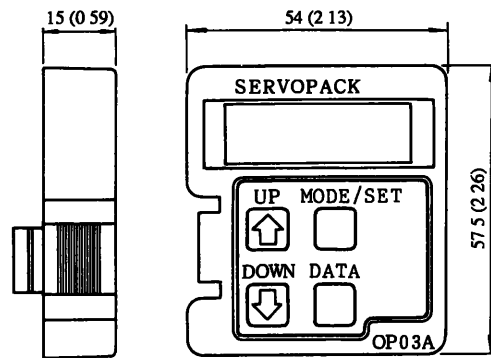

Approx Mass 0.02 kg (0.04 lb)

10.5 CABLES

10.5.1 When Provided by YASKAWA

(1) Cable for Incremental/Absolute Encoder

- For motor with incremental encoder
- Cable with double-end connector

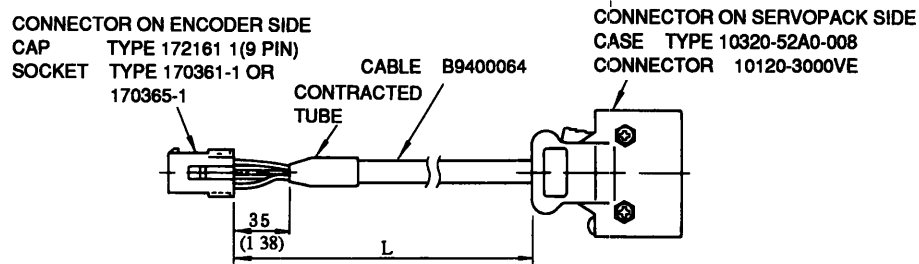

Type	L in mm (feet)
DP9320089-1	3000 $^{+100}_0$ (9 8 $^{+0.33}_0$)
DP9320089-2	5000 $^{+100}_0$ (16 4 $^{+0.33}_0$)
DP9320089-3	10000 $^{+500}_0$ (32 8 $^{+1.61}_0$)
DP9320089-4	15000 $^{+500}_0$ (49 2 $^{+1.61}_0$)
DP9320089-5	20000 $^{+500}_0$ (65 6 $^{+1.61}_0$)

- For motor with absolute encoder
- Cable with double-end connector

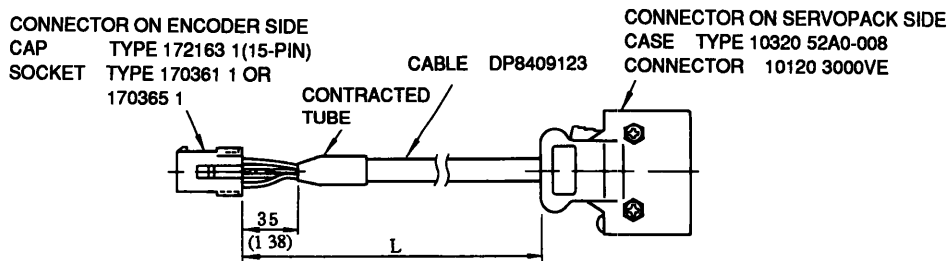

Type	L in mm (feet)
DP9320088-1	3000 $^{+100}_0$ (9 8 $^{+0.33}_0$)
DP9320088-2	5000 $^{+100}_0$ (16 4 $^{+0.33}_0$)
DP9320088-3	10000 $^{+500}_0$ (32 8 $^{+1.61}_0$)
DP9320088-4	15000 $^{+500}_0$ (49 2 $^{+1.61}_0$)
DP9320088-5	20000 $^{+500}_0$ (65 6 $^{+1.61}_0$)

(2) Cable for Motor

- For motor without brake
With connector and amplifier terminal

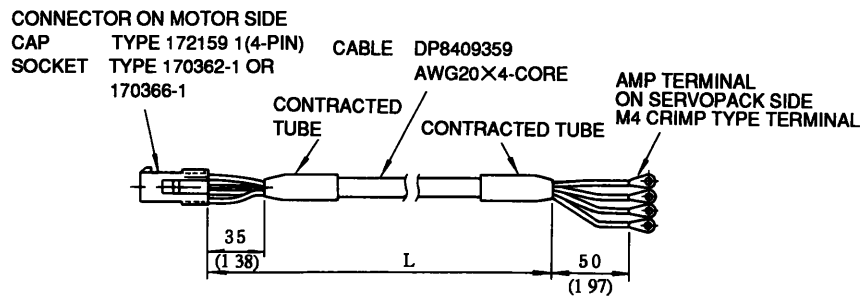

Type	L in mm (feet)
DP9320081-1	3000 $^{+100}_0$ (9 8 $^{+0.33}_0$)
DP9320081-2	5000 $^{+100}_0$ (16 4 $^{+0.33}_0$)
DP9320081-3	10000 $^{+500}_0$ (32 8 $^{+1.64}_0$)
DP9320081-4	15000 $^{+500}_0$ (49 2 $^{+1.64}_0$)
DP9320081-5	20000 $^{+500}_0$ (65 6 $^{+1.64}_0$)

- For motor with brake
With connector and amplifier terminal

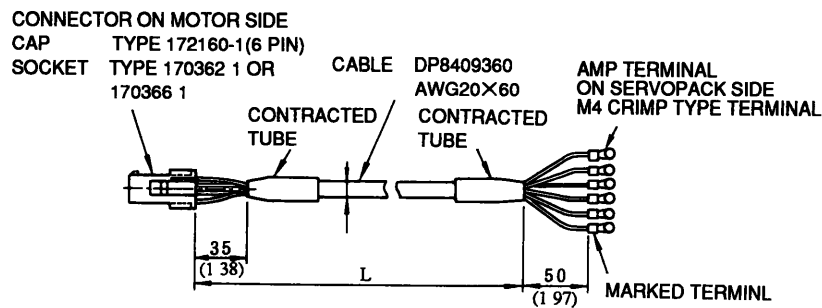

Type	L in mm (feet)
DP9320083-1	3000 $^{+100}_0$ (9 8 $^{+0.33}_0$)
DP9320083-2	5000 $^{+100}_0$ (16 4 $^{+0.33}_0$)
DP9320083-3	10000 $^{+500}_0$ (32 8 $^{+1.64}_0$)
DP9320083-4	15000 $^{+500}_0$ (49 2 $^{+1.64}_0$)
DP9320083-5	20000 $^{+500}_0$ (65 6 $^{+1.64}_0$)

10.5.2 When Connector on SERVOPACK Side is Provided by User

- Cable for incremental encoder (with single connector on SERVOMOTOR side)

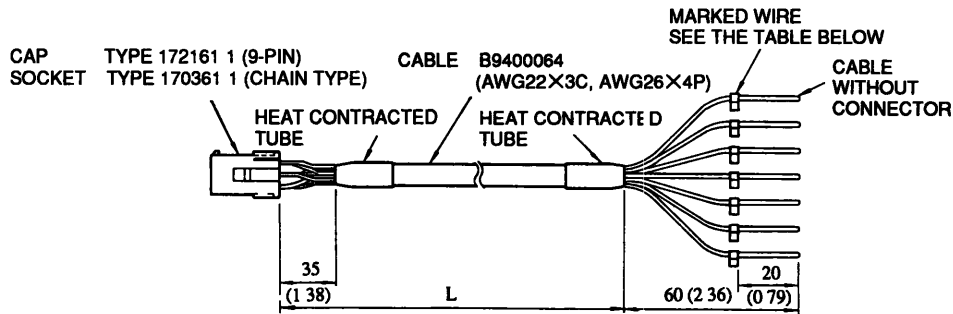

Cable Color Coding

No	Color
1	Black
4	Red
14	Green
15	White/Green
16	Blue
17	White/Blue
18	Yellow
19	White/Yellow
20	Green/Yellow

THE FOLLOWING SHOULD BE PROVIDED BY USER
 CAP TYPE 172161 1
 SOCKET TYPE 170361 1
 CASE 10320-52A0 008
 CONNECTOR 10120 3000VE

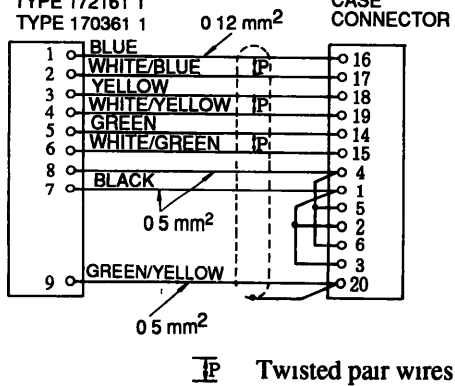

Type	L in mm (feet)
DP9320085-1	3000 ⁺¹⁰⁰ ₀ (9 8 ^{+0.33} ₀)
DP9320085-2	5000 ⁺¹⁰⁰ ₀ (16 4 ^{+0.33} ₀)
DP9320085-3	10000 ⁺¹⁰⁰ ₀ (32 8 ^{+0.33} ₀)
DP9320085-4	15000 ⁺¹⁰⁰ ₀ (49 2 ^{+0.61} ₀)
DP9320085-5	20000 ⁺¹⁰⁰ ₀ (65 6 ^{+0.61} ₀)

• Cable for absolute encoder (with single connector on SERVOMOTOR side)

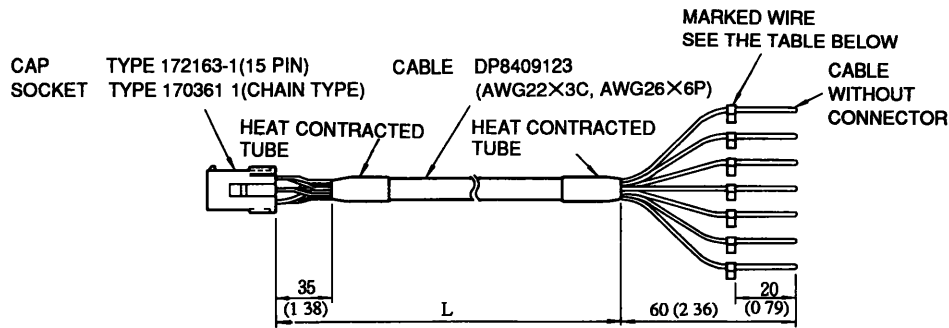

Cable Color Coding

No	Color
1	Black
4	Red
8	Purple
9	White/Purple
10	White/Gray
12	Orange
13	White/Orange
14	Green
15	White/Green
16	Blue
17	White/Blue
18	Yellow
19	White/Yellow
20	Green/Yellow

THE FOLLOWING SHOULD BE PROVIDED BY USER

CASE 10320 52A0 008
(MADE BY SUMITOMO 3M LTD)
CONNECTOR 10120 3000VE
(MADE BY SUMITOMO 3M LTD)

CAP TYPE 172163-1
SOCKET TYPE 170365 1

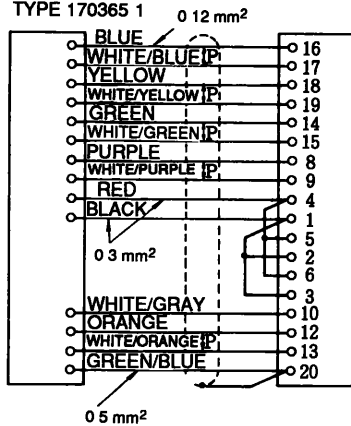

Twisted pair wires

Type	L in mm (feet)
DP9320086-1	3000 ⁺¹⁰⁰ / ₀ (9 8 ^{+0.11} / ₀)
DP9320086-2	5000 ⁺¹⁰⁰ / ₀ (16 4 ^{+0.11} / ₀)
DP9320086-3	10000 ⁺¹⁰⁰ / ₀ (32 8 ^{+1.61} / ₀)
DP9320086-4	15000 ⁺¹⁰⁰ / ₀ (49 2 ^{+1.11} / ₀)
DP9320086-5	20000 ⁺¹⁰⁰ / ₀ (65 6 ^{+1.61} / ₀)

10.5.3 CABLE WITHOUT CONNECTOR

(1) Cable for Incremental/Absolute Encoder

For incremental encoder

Type	L in mm (feet)
DP9400064-1	3000 $^{+100}_0$ (9 8 $^{+0.33}_0$)
DP9400064-2	5000 $^{+100}_0$ (16 4 $^{+0.33}_0$)
DP9400064-3	10000 $^{+500}_0$ (32 8 $^{+1.64}_0$)
DP9400064-4	15000 $^{+500}_0$ (49 2 $^{+1.64}_0$)
DP9400064-5	20000 $^{+500}_0$ (65 6 $^{+1.64}_0$)

THE FOLLOWING SHOULD BE PROVIDED
BY USER
CAP TYPE 172161 1
(MADE BY AMP)
SOCKET TYPE 170361-1 OR
170365 1
(MADE BY AMP)

THE FOLLOWING SHOULD BE PROVIDED
BY USER
CASE 10320-52A0 008 (MADE BY 3M LTD)
CONNECTOR 10120 3000VE (MADE BY 3M LTD)

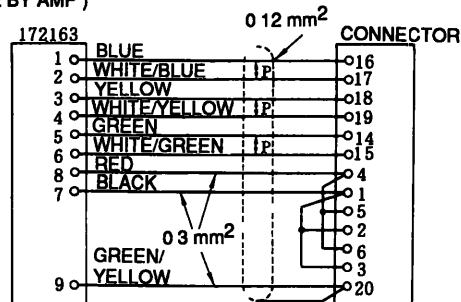

• For absolute encoder

Type	L in mm (feet)
DP8409123-1	3000 $^{+100}_0$ (9 8 $^{+0.33}_0$)
DP8409123-2	5000 $^{+100}_0$ (16 4 $^{+0.33}_0$)
DP8409123-3	10000 $^{+500}_0$ (32 8 $^{+1.61}_0$)
DP8409123-4	15000 $^{+500}_0$ (49 2 $^{+1.61}_0$)
DP8409123-5	20000 $^{+500}_0$ (65 6 $^{+1.61}_0$)

THE FOLLOWING SHOULD BE PROVIDED
BY USER
CAP TYPE 172163-1
SOCKET TYPE 170361 1 OR
170365-1

THE FOLLOWING SHOULD BE PROVIDED
BY USER
CASE 10320 52A0-008 (MADE BY 3M LTD)
CONNECTOR 10120 3000VE (MADE BY 3M LTD)

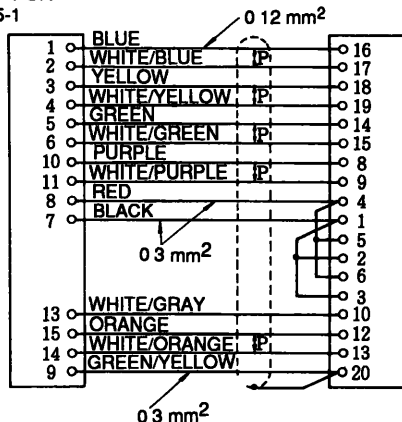

IP Twisted pair wires

Note For details of caps, sockets, cases and connectors, refer to Par 10 6, "CONNECTOR KIT "

(2) Cable for Motor

• For motor without brake

Type	L in mm (feet)
DP8409359-1	3000 $^{+100}_0$ (9 8 $^{+0.33}_0$)
DP8409359-2	5000 $^{+100}_0$ (16 4 $^{+0.33}_0$)
DP8409359-3	10000 $^{+500}_0$ (32 8 $^{+1.64}_0$)
DP8409359-4	15000 $^{+500}_0$ (49 2 $^{+1.64}_0$)
DP8409359-5	20000 $^{+500}_0$ (65 6 $^{+1.64}_0$)

• For motor with brake

Type	L in mm (feet)
DP8409360-1	3000 $^{+100}_0$ (9 8 $^{+0.33}_0$)
DP8409360-2	5000 $^{+100}_0$ (16 4 $^{+0.33}_0$)
DP8409360-3	10000 $^{+500}_0$ (32 8 $^{+1.64}_0$)
DP8409360-4	15000 $^{+500}_0$ (49 2 $^{+1.64}_0$)
DP8409360-5	20000 $^{+500}_0$ (65 6 $^{+1.64}_0$)

AMP CONNECTOR
 CAP TYPE 172159 1
 SOCKET TYPE 170362 1 OR
 170366 1 (MADE BY AMP)

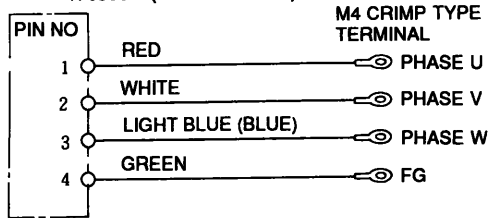

AMP CONNECTOR
 CAP TYPE 172160 1
 SOCKET TYPE 170362 1 OR
 170366 1 (MADE BY AMP)

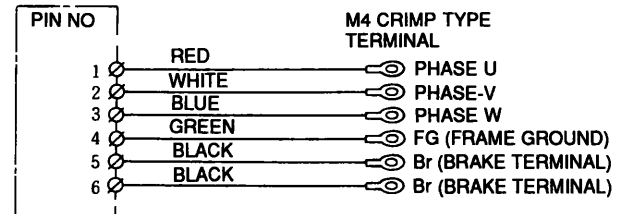

Note For details of caps and sockets, refer to Par 10 6, "CONNECTOR KIT "

10.6 CONNECTOR KIT

(1)-A Cap for Encoder Cable

For incremental encoder

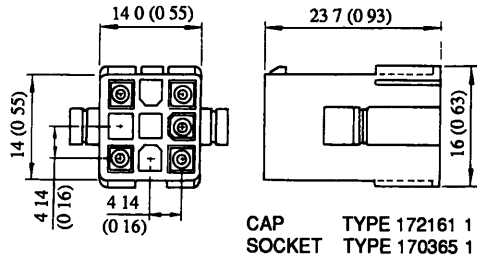

(1)-B Cap for Encoder Cable

For absolute encoder

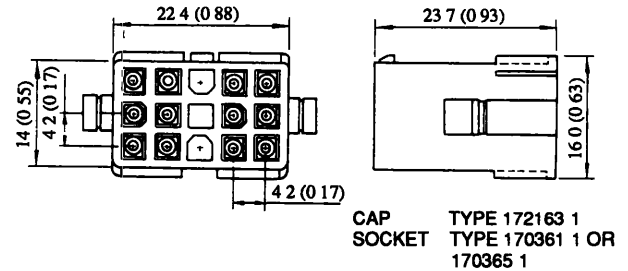

(2)-A Cap for Motor Cable

For motor without brake

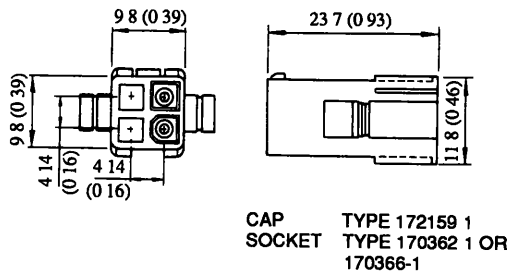

(2)-B Cap for Motor Cable

For motor with brake

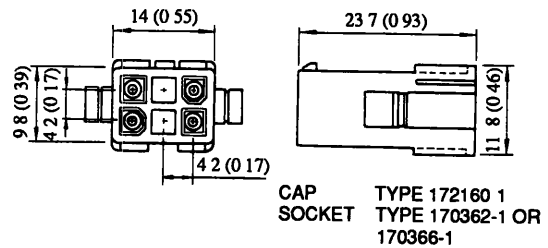

(3) SGD SERVOPACK 1CN, 2CN

Connector

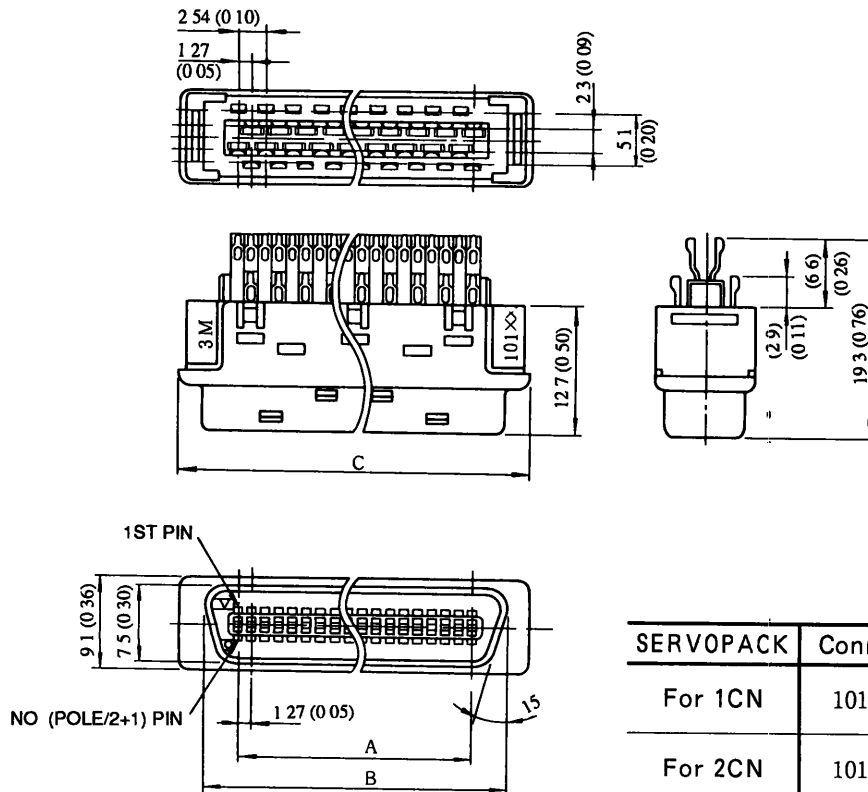

in mm (inches)

SERVOPACK	Connector Type	A	B	C
For 1CN	10136-3000VE	21.59 (0.85)	27.8 (1.09)	32.2 (1.27)
For 2CN	10120-3000VE	11.43 (0.45)	17.6 (0.69)	22.0 (0.87)

• Case

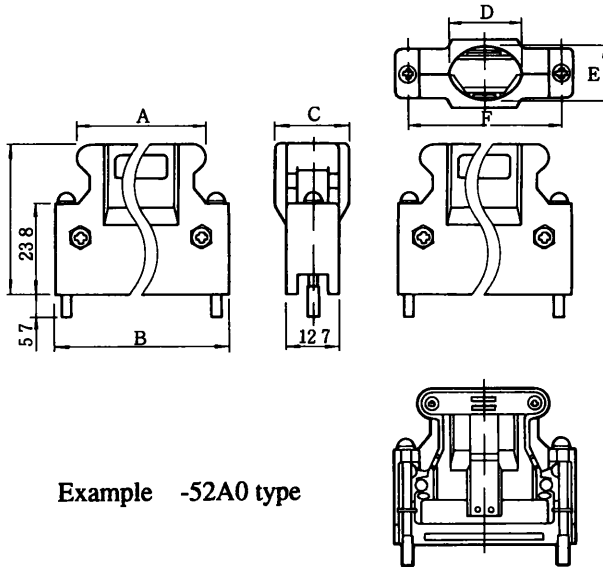

Example -52A0 type

in mm (inches)

SERVOPACK	Connector Type	Shell Type	A	B	C	D	E	F
For 1CN	10136-3000VE	10336-52A0-008	32.2 (1.27)	43.5 (1.71)	18.0 (0.71)	17.0 (0.67)	14.0 (0.55)	37.6 (1.48)
For 2CN	10120-3000VE	10320-52A0-008	22.0 (0.87)	18.0 (0.71)	14.0 (0.55)	12.0 (0.47)	10.0 (0.39)	27.4 (1.08)

Connector Kit Type	Application		Connector Kit Parts List													
	For Encoder/ Motor Cable		For Encoder Cable								For Motor Cable					
			On Encoder Side				On SERVOPACK Side									
	Encoder Type	Motor Brake	Cap		Socket		Connector		Case		Cap		Socket			
Type			Qty	Type	Qty	Type	Qty	Type	Qty	Type	Qty	Type	Qty			
DP9420006-1	Incremental encoder	Without	172161-1*	1		‡	10					172159-1*	1		5‡	
DP9420006-2	Incremental encoder	With			170365-1*			10120 †	1	10320-†	52A0-008	1-set	172160-1*	1	170366-1*	7‡
DP9420006-3	Absolute encoder	Without				‡	16					172159-1*	1		5‡	
DP9420006-4	Absolute encoder	With	172163-1 †	1								162160-1*	1		7‡	

Connector Kit Type	Application	Connector Kit Parts List			
		Connector		Case	
		Type	Qty	Type	Qty
DP9420007	I/O connector for 1CN	10136 †	1	10336-†	1-set

* Made by AMP

† Made by 3M

‡ Including 1 spare

10.7 NOISE FILTER

· Type LF-205A

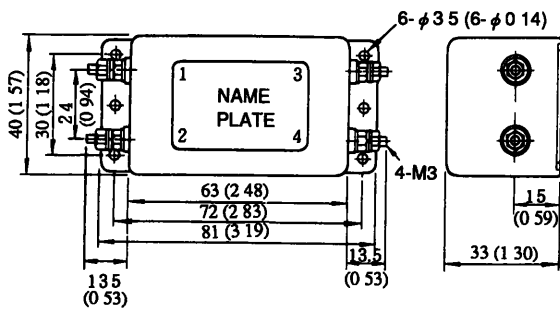

· Type LF-220

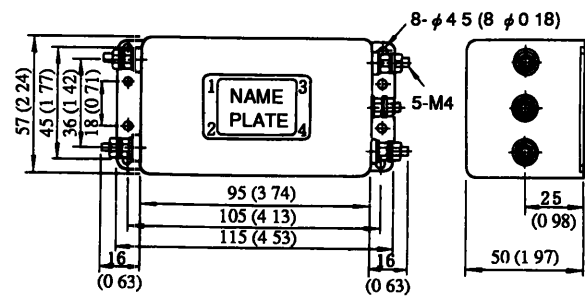

· Type LF-210

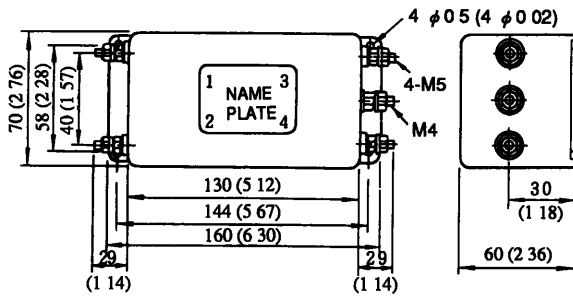

Made by Tokin Corp

10.8 PERIPHERAL DEVICES

(1) Variable Resistor for Speed Setting

- Type 25HP-10B

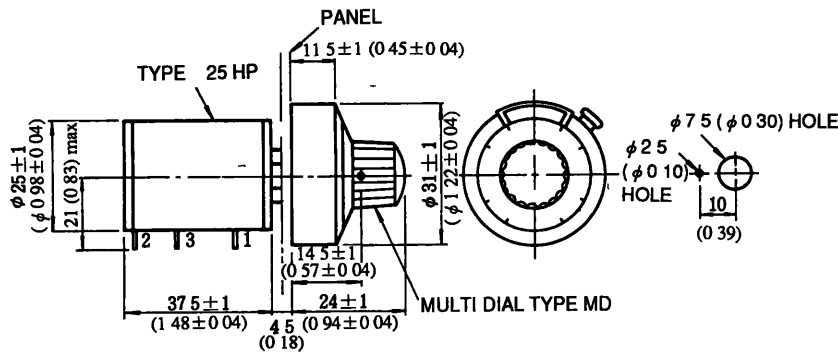

(2) Power Supply for Brake

You can select two types of power supply for brake (100/200 VAC)

- Input 100 VAC/90 VDC (DP8401002-2)
- Input 200 VAC/90 VDC (DP8401002-1)
- Internal circuit for 100 VAC

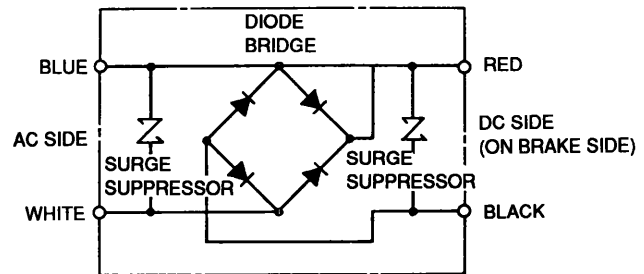
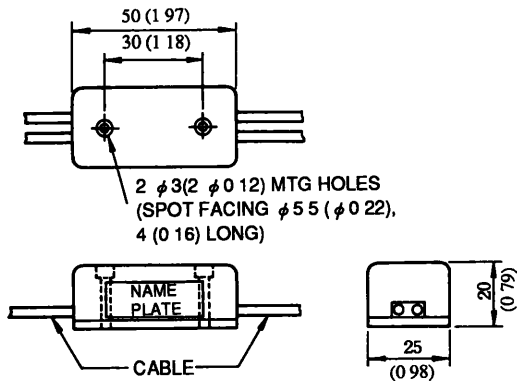

Internal circuit for 200 VAC

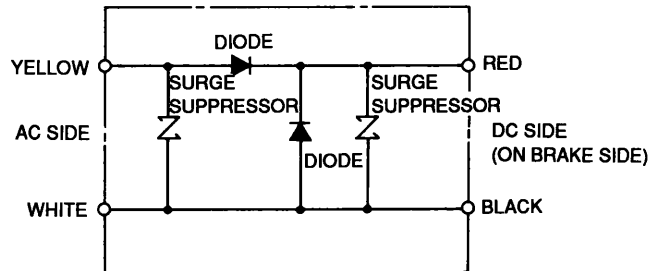

- Cable length 500 mm each
- Cables are distinguished by color

AC Input Side		On Brake Side
100 V	200 V	
Blue, White	Yellow, White	Red, Black

Note The brake power circuit can be turned ON and OFF on either the AC or DC side. Normally, switching on the AC side is safer. If switched on the DC side, surge voltage may damage the brake coil. To avoid this, place a surge suppressor near the brake coil.

(3) Connector to Terminal Conversion Unit (Type JUSP-TA36P □)

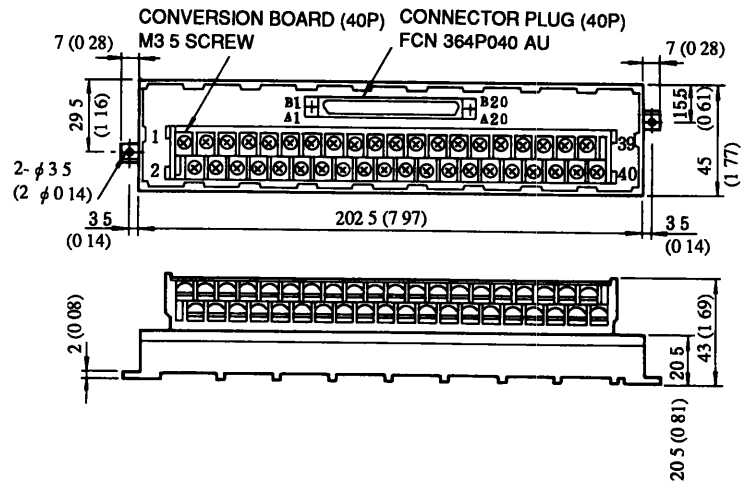

11. TEST RUN

Before test run, check the following Correct any deficiency

11.1 CHECK ITEMS BEFORE TEST RUN

11.1.1 SGM SERVOMOTOR

Before test run, check the following If the test run is performed after long storage, see Par 13, "INSPECTION AND MAINTENANCE "

- Connection to machines or devices, wiring, and grounding are correct
- Bolts and nuts are tightened
- For motors with shaft seals, the seals are not damaged and motor is properly lubricated

11.1.2 SGD SERVOPACK

- Parameters are correctly set to satisfy the specifications for the applicable SERVOMOTOR
- Connection and wiring leads are firmly connected to terminals or inserted into the connectors
- The power supply is turned OFF if servo alarm occurs
- Voltage supplied to SGD SERVOPACK is 200 to 230 VAC^{+10%}_{-15%} (100 to 115 VAC^{+10%}_{-15%})
If a voltage line other than 200 V (100 V) is used, the voltage should be dropped to 200 V (100 V) through a power transformer
- The speed reference should be 0 V

11.2 TEST RUN PROCEDURES

11.2.1 Preparation for Operation

During test run, loads should not be applied to the SERVOMOTOR If it is necessary to start with the driven machine connected to the motor, confirm that the driven system is ready for emergency stop at any time

(1) Power ON

After checking items in Par 6 1, turn ON the power supply When the power ON sequence is correct, according to Par 6 1, the power is turned ON by depressing the POWER pushbutton for approximately 2 second

- (2) If power is supplied normally, the power ON indicator LED (green) lights and the alarm LED (red) goes OFF When a digital operator is used, the display shown below appears when power is supplied normally (This display appears when the motor stops)

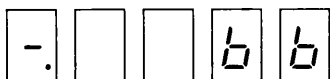

- (3) Inputting the servo ON signal (by switching ON the contact) activates the power circuit in the SGD SERVOPACK to be ready to drive the motor (The display shown below appears on the digital operator, provided that the motor is stopped.)

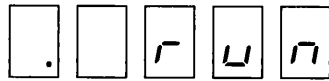

11.2.2 Operation

The operation is possible only while Servo ON signal is ON

• In Speed Control Mode

- (1) Increase the speed reference voltage gradually from 0 V, then the motor rotates at a speed proportional to the reference voltage



- (2) When the reference voltage is positive, the motor rotates in the forward direction (counterclockwise rotation when viewed from the shaft extension)

• In Torque Control Mode

- (1) Increase torque reference gradually from 0 V, then the motor rotates at a torque proportional to the reference voltage.

NOTE

Since no speed control is applied, motor rotation speed cannot be controlled. Take special care to avoid overrunning.



- (2) When the reference voltage is positive, the motor rotates in the forward direction (counterclockwise rotation when viewed from the shaft extension)

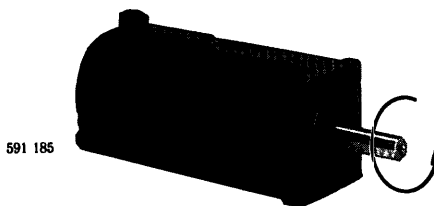

Fig 11 1 Motor Forward Running

11.2.3 Inspection during Test Run

The following items should be checked for during the test run

- Unusual vibration
- Abnormal noise
- Excessive temperature rise

If any fault is found, take corrective actions according to Par 14. At a test operation, the load and machine may not fit well at first and result in overload.

12. ADJUSTMENT

12.1 CHARACTERISTICS PRESET AT THE FACTORY PRIOR TO SHIPMENT

Standard factory setting is speed control mode. To change to torque control mode, set up bit A or B of user constant Cn-02. Characteristics preset at the factory are shown below.

- In Speed Control Mode

(1) Speed Reference Input – SERVOMOTOR Speed Ratio

Condition: No load

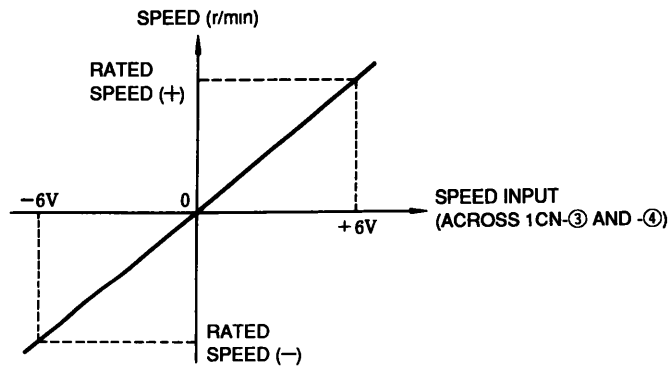

Fig 12.1 Speed Reference Input – SERVOMOTOR Speed Ratio

(2) Start – Stop Response Characteristics

Condition

I_P Start current set value

Load inertia $J_L = \text{motor inertia } J_M \times 3$

Both overshoot (N_{OV}) and undershoot (N_{UD}) are 5% or less

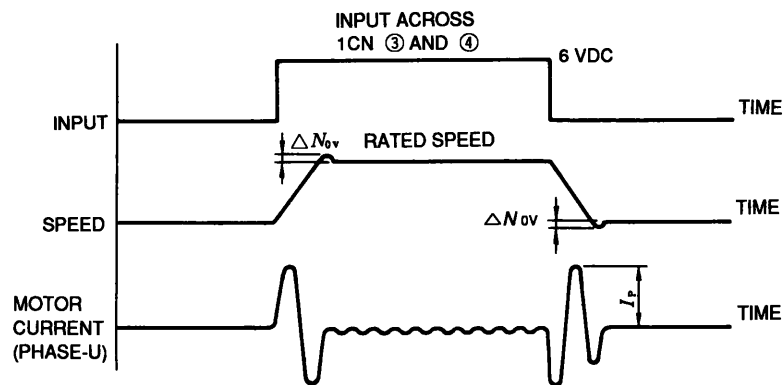

Fig 12.2 Start – Stop Response Characteristics

(3) Speed Regulation

Speed regulation $\Delta N, \Delta n$

$$\frac{\Delta n}{N_R} \times 100\% \leq 0.03\%$$

$$\frac{\Delta N}{N_R} \times 100\% \leq 0.015\%$$

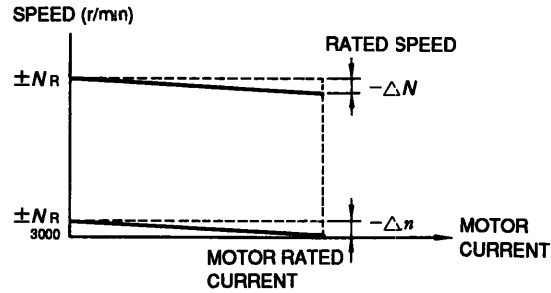

Fig 12 3 Speed Regulation

• In Torque Control Mode

(1) Torque reference input – Torque characteristics

Conditions No load

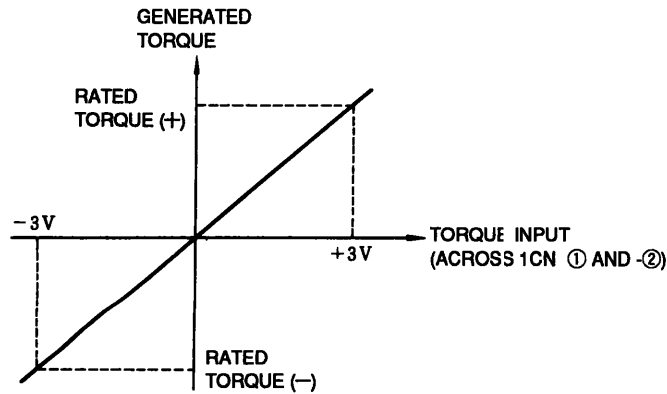

Fig 12 4 Torque Reference Input – Torque Characteristics

12.2 RESET

If resetting of parameters is necessary, refer to Par 8: "DIGITAL OPERATOR (JUSP-OP02A-1, -OP03A)"

13. INSPECTION AND MAINTENANCE

13.1 SGM SERVOMOTOR

SGM SERVOMOTOR has no movable wearing parts (eg brushes), so simple daily inspection is sufficient. The inspection schedule for the motor is shown in Table 13.1

Do not disassemble the motor. If disassembly should become necessary, contact your YASKAWA representative.

Table 13.1 Inspection Schedule for Motors

Inspection Item	Frequency	Inspection Operation
Vibration	Daily	Touch by hand
Noise	Daily	Aurally
Exterior and Cleaning	As required	Clean with dry cloth or compressed air
Insulation Resistance	Annually	Make sure that it is more than 10MΩ by measuring with a 500V megger after disconnecting the motor from the controller
Shaft Seal	Every 5000 hours	Replace shaft seal
Overhaul	Every 20,000 hours or 5 years	If worn or damaged, replace after disconnecting the motor from the driven machine. Contact your YASKAWA representative.

13.2 SGD SERVOPACK

SGD SERVOPACK does not require any special maintenance. Remove dust and tighten screws periodically.

13.3 PRECAUTIONS FOR BATTERY REPLACEMENT

The life of the lithium battery (type ER6VC, made by Toshiba Corp.) is approximately 10 years. The battery for absolute encoder (provided by user) is replaced as follows:

- 1 * After SERVOPACK power is turned ON, SEN signal remains at a high-level for 3 minutes minimum (The capacitor in encoder is charged.)
- 2 Replace the battery (SERVOPACK power may be turned OFF or ON.)

The encoder position data remains in the same way as prior to replacement.

*After this operation is performed, the encoder will operate normally for two days maximum even without a battery.

14. TROUBLESHOOTING

14.1 SGM SERVOMOTOR

WARNING

Corrective actions in  should be performed after turning OFF the power

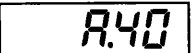

Table 14 1 Troubleshooting Guide for AC SERVOMOTOR

Trouble	Cause	What to do
Motor does not start	Loose connection	Tighten connection
	Wrong wiring	Correct wiring
	Overload	Reduce load or use a larger motor
Unstable operation	Wrong wiring	Inspect and correct wiring across motor terminals U, V, and W, and PG
Motor overheats	Excessive ambient temperature	Reduce ambient temperature below 40°C
	Motor surface is dirty	Clean motor surface
	Overload	Reduce load or use a larger motor
Unusual noise	Motor loosely mounted	Tighten foundation bolts
	Motor misaligned	Realign with driven machine
	Coupling out of balance	Balance coupling
	Noisy bearings	Check alignment, noise of bearings, lubrication and contact your YASKAWA representative
	Vibration of driven machine	Contact the machine manufacturer

14.2 SGD SERVOPACK

14.2.1 LED Indication (7-segment) for Troubleshooting



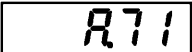
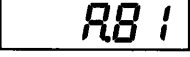
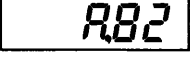

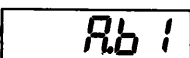

Table 14 2 LED Indication for Troubleshooting

Digital Operator Indication* (Traceback Monitor)	Lighting Condition	Probable Cause	Corrective Actions
 Overcurrent	Goes ON when power is supplied to the control circuit	Defective control circuit board (1PWB)	Replace the SERVOPACK
	Goes ON when power is supplied to the main circuit and servo power is turned ON	<ul style="list-style-type: none"> Defective current feedback circuit Defective main circuit transistor module Motor grounding 	<ul style="list-style-type: none"> Replace the SERVOPACK Correct grounding
	Lights during operation Lights even after turning power OFF and then ON again Operation is restarted after turning power OFF, waiting for a while, and resetting	Ambient temperature near the SERVOPACK is over 55°C	Reduce ambient temperature around the SERVOPACK to 55°C or lower (Heat sink overheat)
 Overvoltage	Goes ON when the motor accelerates or decelerates	Load inertia J_L is too large	<ul style="list-style-type: none"> Check the inertia of the machine with the value at the motor output shaft Connect the regenerative unit
		Defective regenerative circuit	Replace the SERVOPACK
 Overspeed	When the reference is input, the motor runs fast and LED goes ON	<ul style="list-style-type: none"> Motor connection error Absolute encoder connection error Improper gain adjustment 	<ul style="list-style-type: none"> Correct the motor connection Check pulses in phases A, B and C on 2CN and correct wiring Correct gains
 Overspeed Reference	When the reference is input, the motor runs fast and LED goes ON	The reference input voltage is too large	Decrease the reference input voltage
 Instantaneous Overload	Goes ON during operation When power to the control circuit is turned OFF and then turned ON again, the operation starts	Operation is continued for several seconds to several tens seconds at a torque exceeding the rating	Check for overload and adjust as necessary

* Display format is as indicated





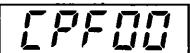
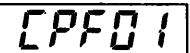



Table 14 2 LED Indication for Troubleshooting (Cont'd)

Digital Operator Indication* (Traceback Monitor)	Lighting Condition	Probable Cause	Corrective Actions
 Continuous Overload	Goes ON during operation When power to the control circuit is turned OFF and then turned ON again, the operation starts	<ul style="list-style-type: none"> • Operation is continued for several tens of seconds to several hundreds of seconds at a torque exceeding the rating • Motor connection 	<ul style="list-style-type: none"> • Check for overload and adjust as necessary • Correct wiring U → A, V → B, W → C
 Encoder Error	Goes ON during operation	<p>Erroneous wiring or incomplete contact of the absolute encoder</p> <p>Malfunction of the SERVOPACK pulse counter</p>	<p>Check and correct signal cables of phases A, B and C of 2CN</p> <ul style="list-style-type: none"> • Turn OFF the SEN signal, reset the alarm, then turn ON the SEN signal again • Take noise-control measures
 Encoder Backup Error	Goes ON after SEN signal is input	Absolute encoder backup voltage dropped	Set up the absolute encoder
 Encoder Checksum Error	Goes ON after SEN signal is input	Absolute encoder memory data check error	Set up the absolute encoder
 Encoder Battery Alarm	Goes ON after SEN signal is input	Absolute encoder battery voltage dropped	Replace the battery and enter the SEN signal twice
 Encode Overspeed	Goes ON after SEN signal is input	The motor is turning when the SEN signal is input	Enter the SEN signal when the motor stops
 Reference Read Error	Goes ON during operation	<p>Erroneous operation with the reference input reader</p> <p>Failure of the reference input reader</p>	<p>Resume after resetting operation</p> <p>Replace the SERVOPACK</p>
 Overrun	The motor starts momentarily, then LED goes ON	<p>Motor connection error</p> <p>Encoder connection error</p>	<p>Correct the motor connection</p> <p>Correct wiring of the optical encoder</p>

* Display format is as indicated



Table 14 2 LED Indication for Troubleshooting (Cont'd)

Digital Operator Indication* (Traceback Monitor)	Lighting Condition	Probable Cause	Corrective Actions
 Wire Break with Phase PA, PB	The motor starts momentarily, then LED goes ON	Wire break with phase PA or PB of the optical encoder	Correct signal cables of the optical encoder
 Wire Break with Phase PC	The motor starts momentarily, then LED goes ON	Wire break with phase PC of the encoder	Correct signal cables of the optical encoder
 Digital Operator Transmission Error 1	Goes ON when power is supplied to the control circuit	Poor connection between digital operator and SGD SERVOPACK	Check the connection
		Defective SGD SERVOPACK board (1PWB)	Replace the SERVOPACK
		Digital operator failure	Replace the digital operator
 Digital operator Transmission Error 2	Goes ON when power is supplied to the control circuit	Defective control circuit board (1PWB)	Replace the SERVOPACK
		Goes ON during operation	Malfunction of the internal circuit
			Failure of the internal circuit
 Absolute Encoder Error	Goes ON after SEN signal is input	Absolute encoder works incorrectly	<ul style="list-style-type: none"> • Enter the SEN signal again • Set up the absolute encoder
		Absolute encoder connection error	Correct wiring of the absolute encoder
 Parameter Failure	Goes ON when power is turned ON	Defective control circuit board (1PWB)	Replace the SERVOPACK
 Parameter Setting Error	Goes ON when power is turned ON	Set the value without a setting range by serial communication	Reset the value

* Display format is as indicated



† Alarm A 00 is reset only by turning OFF the power Normal alarm reset methods are invalid

‡ CPU faults are not recorded in traceback data

14.2.2 Examples of Troubleshooting for Defective Wiring or Parts (Table 14 3)

Table 14 3 Examples of Troubleshooting for Defective Wiring or Parts

Trouble	Check Items	Corrective Actions
Fuse is blown immediately after Power ON and Servo ON	<ul style="list-style-type: none"> • Main circuit wiring (such as motor grounding) 	<ul style="list-style-type: none"> • Correct the wiring
The reference is input, but the motor does not run	<ul style="list-style-type: none"> • Voltage across \textcircled{R} and \textcircled{T} • Alarm LED OFF • Speed reference voltage • P-CON, N-OT, P-OT, S-ON • SEN signal (for absolute encoder) • Digital operator display 	<ul style="list-style-type: none"> • Check the AC power supply circuit • If LED is ON, check the cause • Adjust the speed setting potentiometer (supplied by the user)

14.2.3 Examples of Errors Resulting Setting Errors (Table 14 4)

Table 14 4 Examples of Errors Resulting Setting Errors

Error Condition	Cause	Corrective Actions
The motor vibrates at a high frequency of about 200 to 300 Hz (The vibration frequency matches commercial frequency)	Speed loop gain is too high (influence by induced noise in the SERVOPACK input circuit since the cable is too long or is bundled together with a power line)	Adjust Cn-04 <u>LOOP Hz</u> to reduce speed loop gain until vibration stops Separate the input circuit cable from the power lines or receive power to the input circuit from a power supply of a lower impedance (about 100Ω or lower AC is allowable)
Too much overshoot is observed with the rotation speed at acceleration and deceleration	Speed loop gain is too high	Adjust Cn-04 <u>LOOP Hz</u> to reduce speed loop gain until vibration stops
The motor turns even when speed reference voltage is 0 V	There is an offset to the speed reference voltage	Adjust the offset to the speed reference voltage (See Par 8 4 4, "Speed Reference Offset Adjustment ")

14.2.4 Cause and Corrective Actions : No Alarm is Displayed but the Motor does not Run

Table 14 5

Trouble	Cause	Condition	Corrective Actions
The motor does not run at all	The SEN signal input is OFF	Only for motor with absolute encoder Bit 1 of Cn-01 is 0	Turn ON the SEN signal
	The servo-ON signal input is OFF	Bit 0 of Cn-01 is 0	Turn ON the servo-ON signal
	Cables of the encoder and motor are not connected		Connect the cables
	The encoder is not suitable for the SGD SERVOPACK		Use the applicable encoder
	The P-OT or N-OT input signal is OFF	Bit 2 or 3 of Cn-01 is 0	Turn ON the P-OT or N-OT input signal
The motor moves momentarily, then stops and does not start again	The number of pulses of the encoder being used does not match the set value of Cn-11		Set proper value for Cn-11
	Connection of the motor and the encoder are wrong		Correct the connections
The motor suddenly stops during operation and does not start again	An alarm occurs while the alarm reset signal is ON		Remove the cause of the alarm, then turn the alarm reset signal input ON and OFF
	Zero clamp operation is not canceled	Speed control is used, and bit 8 of Cn-01 is 0 and bit A of Cn-01 is 1	Turn OFF the $\overline{\text{P-CON}}$ input signal to cancel zero clamp operation

NOTES

Σ SERIES SGM/SGD BULLETIN

TOKYO OFFICE New Pier Takesiba South Tower 1 16 1 Kaigan Minatoku Tokyo 105 Japan
Phone 81 3 5402 4511 Fax 81 3 5402 4580

YASKAWA ELECTRIC AMERICA INC

Chicago-Corporate Headquarters 2942 MacArthur Blvd Northbrook IL 60062 2028 U S A
Phone 1 847 291 2340 Fax 1 847 498 2430

Chicago-Technical Center 3160 MacArthur Blvd Northbrook IL 60062 1917 U S A
Phone 1 847 291 0411 Fax 1 847 291 1018

MOTOMAN INC

805 Liberty Lane West Carrollton OH 45449 U S A
Phone 1 513 847 6200 Fax 1 513 847 6277

YASKAWA ELÉTRICO DO BRASIL COMÉRCIO LTDA

Avenida Brigadeiro Faria Lima 1664 5 CJ 504/511 Sao Paulo Brazil
Phone 55 11 815 7723 Fax 55 11 870 3849

YASKAWA ELECTRIC EUROPE GmbH

Am Kronberger Hang 2 65824 Schwalbach Germany
Phone 49 6196 569 300 Fax 49 6196 888 301

Motoman Robotics AB

Box 504 S38525 Torsas Sweden
Phone 46 486 10575 Fax 46 486 41410

Motoman Robotec GmbH

Kammerfeldstraße 1 85391 Allershausen Germany
Phone 49 8166 900 Fax 49 8166 9039

YASKAWA ELECTRIC UK LTD

3 Drum Mains Park Orchardton Woods Cumbernauld Scotland G68 9LD U K
Phone 44 1236 735000 Fax 44 1236 458182

YASKAWA ELECTRIC KOREA CORPORATION

Paik Nam Bldg 901 188 3 1 Ga Euljiro Joong Gu Seoul Korea
Phone 82 2 776 7844 Fax 82 2 753 2639

YASKAWA ELECTRIC (SINGAPORE) PTE LTD

151 Lorong Chuan #04 01 New Tech Park Singapore 556741 Singapore
Phone 65 282 3003 Fax 65 289 3003

YATEC ENGINEERING CORPORATION

Shen Hsiang Tang Sung Chiang Building 10F 146 Sung Chiang Road Taipei Taiwan
Phone 886 2 563 0010 Fax 886 2 567 4677

BEIJING OFFICE Room No 301 Office Building of Beijing International Club 21 Jianguomenwai Avenue Beijing 100020 China
Phone 86 10 532 1850 Fax 86 10 532 1851

SHANGHAI OFFICE Room No 8B Wan Zhong Building 1303 Yan An Road (West) Shanghai 200050 China

Phone 86 21 6212 1015 Fax 86 21 6212 1326

YASKAWA JASON (HK) COMPANY LIMITED

Rm 2916 Hong Kong Plaza 186 191 Connaught Road West Hong Kong
Phone 852 2858 3220 Fax 852 2547 5773

TAIPEI OFFICE Shen Hsiang Tang Sung Chiang Building 10F 146 Sung Chiang Road Taipei Taiwan

Phone 886 2 563 0010 Fax 886 2 567 4677



YASKAWA

YASKAWA ELECTRIC CORPORATION

TSE-S800-15 1C

© Printed in Japan January 1997 93 7-79 8 0 2TA ③

Due to ongoing product modification/improvement, data subject to change without notice

789 13